

HIGH-TENSILE WIRE FENCING

ACKNOWLEDGMENTS

The authors thank John Wall, Kiwi Fence Systems; Bill Sears, West Virginia Fence Corporation; Charles Kendall, Kencove Fence, for their suggestions and review of the manuscript; and Mark R. Ellingwood, Connecticut Bureau of Wildlife; Raymond J. Winchcombe, Institute of Ecosystem Studies; Henry Swayze, Brookside Industries; Kris Owen, Koppers Company; and United States Steel for their help in preparing the original edition.

ABOUT NRAES

NRAES, the Natural Resource, Agriculture, and Engineering Service (formerly the Northeast Regional Agricultural Engineering Service), is an interdisciplinary, issues-oriented program focused on delivering educational materials and training opportunities in support of cooperative extension. The mission of NRAES is to assist faculty and staff at member land grant universities in increasing the availability of research- and experience-based knowledge to (1) improve the competitiveness and sustainability of agriculture and natural resources enterprises, (2) increase understanding of processes that safeguard the food supply, and (3) promote environmental protection and enhancement. All NRAES activities are guided by faculty from member land grant universities (see the map below for a list of cooperating members).

NRAES began in 1974 through an agreement among the cooperative extension programs in the Northeast. In 1998, Virginia Polytechnic Institute and State University became an NRAES member university. Currently, NRAES has published more than 95 publications and distributes a total of more than 160 publications on the following topics: general agriculture, aquaculture, agrichemical handling, IPM, horticulture, greenhouses, building construction, livestock and poultry, dairy, waste management, composting, farm management, farm safety, forestry and wildlife, and home. Please contact us for a free copy of our publications catalog. Office hours are Monday through Thursday, 8:30 A.M. to 5:00 P.M., and Friday, 8:30 A.M. to 2:30 P.M., eastern time.

NRAES (Natural Resource, Agriculture, and Engineering Service)
Cooperative Extension
152 Riley-Robb Hall
Ithaca, New York 14853-5701

Phone: (607) 255-7654
Fax: (607) 254-8770
E-mail: NRAES@CORNELL.EDU
Web site: WWW.NRAES.ORG

NRAES Member Universities

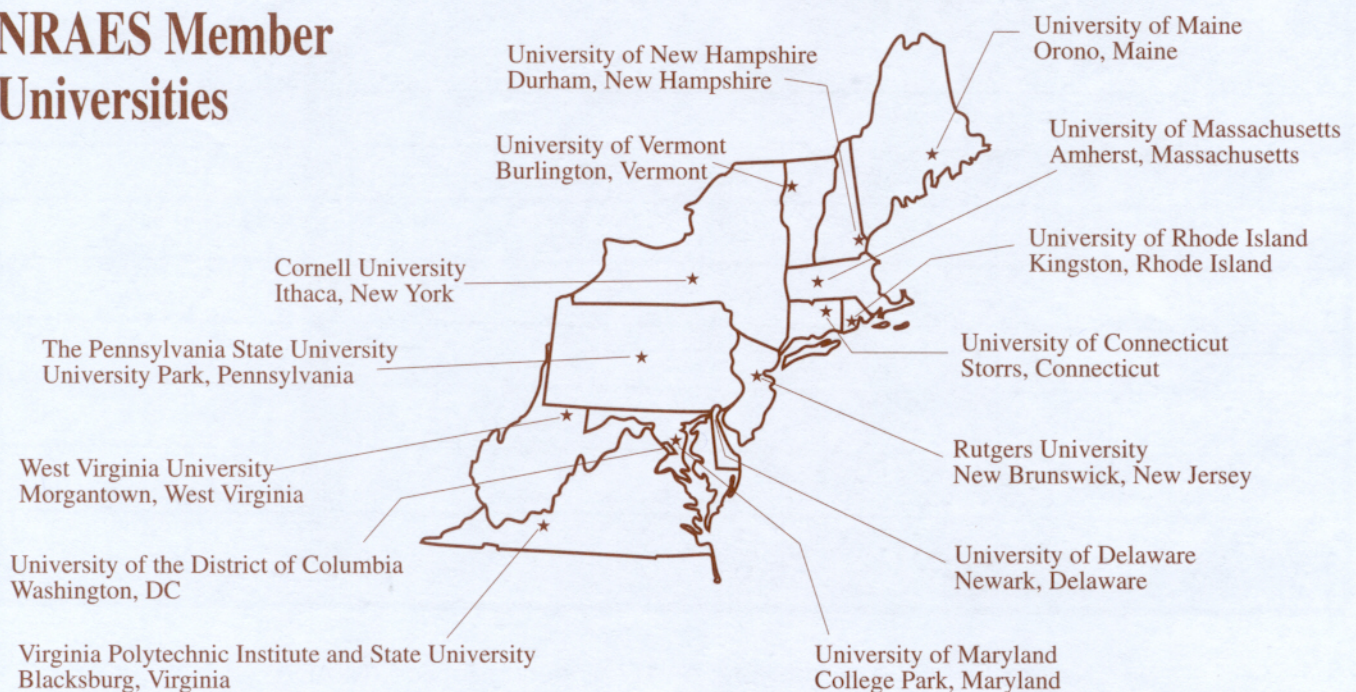

HIGH-TENSILE WIRE FENCING

Written by

Arthur W. Selders, West Virginia University, Morgantown, WV
Jay B. McAninch, Institute of Ecosystem Studies at
the Mary Flagler Cary Arboretum, Millbrook, NY

Illustrations by Michael J. Kridle, West Virginia University
Cover Art & Publication Design by Mabel Chan
Edited by Martin A. Sailus, Marcia Sanders

Natural Resource, Agriculture, and Engineering Service (NRAES)
Cooperative Extension
152 Riley-Robb Hall
Ithaca, NY 14853-5701

CONTENTS

INTRODUCTION	1
NON-ELECTRIC FENCE CONSTRUCTION	2
Staples	5
Tensioning Wire	5
Wire Spacers	5
Mechanical Fasteners vs. Wire Knots	6
Grounding Non-Electric Fence	6
ELECTRIC FENCE	9
Energizers	11
Grounding	11
Identifying Electric Fences	11
LIGHTWEIGHT HIGH-TENSILE FENCE	13
HIGH-TENSILE FENCING FOR DEER CONTROL	14
Vertical Fence	14
Slanted Fence	15
Woven and Smooth Wire Fence	16
MAINTENANCE AND SAFETY FOR HIGH-TENSILE FENCE	21
REFERENCES	Inside Back Cover

NRAES-11
Revised September 1987

© 1987 by the Natural Resource, Agriculture, and Engineering Service
All rights reserved. Inquiries invited.

ISBN 0-935817-03-4

Requests to reprint parts of this publication should be sent to NRAES. In your request, please state which parts of the publication you would like to reprint and describe how you intend to use the reprinted material. Contact NRAES if you have any questions.

Natural Resource, Agriculture, and Engineering Service (NRAES)
Cooperative Extension, 152 Riley-Robb Hall
Ithaca, New York 14853-5701
Phone: (607) 255-7654 • Fax: (607) 254-8770
E-mail: NRAES@CORNELL.EDU • Web site: WWW.NRAES.ORG

HIGH-TENSILE WIRE FENCING

High-tensile wire fencing, introduced to the United States from Australia and New Zealand, is creating considerable interest because it has a longer life and costs less than conventional fences. High-tensile smooth wire fences are constructed mostly with 12 1/2 or 14 gauge Class 3 wire with tensile strengths from 170,000 to 200,000 or more pounds per square inch (psi) and breaking strengths up to nearly 1,800 pounds. ASTM Specification A854/A854M-86 covers 12 1/2 gauge steel wire for wire fence, trellis, and similar structures. Conventional galvanized (Class 1) fencing wire has about a 50,000-60,000 psi tensile strength. Lighter weight high-tensile (HT) Class 3 galvanized wire (16 gauge) with a breaking strength about one-third that of 12 1/2 gauge is also available. It is suitable only for fence designs specially tailored for this wire, such as subdivision fencing for controlled or intensive grazing systems. A ten-strand high-tensile non-electric smooth wire fence costs about two-thirds that of an equivalent woven wire fence.

Wires are held in tension along wood or fiber glass posts, or a combination of posts and battens or droppers. This fence can withstand over 1,100 pounds of livestock pressure or low temperature contraction without losing its elasticity, yet it may be flexible enough to bend, wrap, tie in knots, or clamp with crimping sleeves. The high elastic limit of high-tensile wire reduces the common stretch or sag problems associ-

ated with conventional fence wire. Tension in the wire is maintained by permanent in-line strainers. A tension indicator spring may be used to indicate wire tension.

High-tensile smooth wire fence has several other advantages over conventional fencing as it:

- is easier to handle
- is safer for livestock
- is easily adapted to specific needs
- requires little maintenance
- does minimum damage to livestock hides
- has a neat appearance
- is easily electrified to give better livestock restraint and predator protection.

Designs for high-tensile wire fence systems are available for all types of livestock. Electric and non-electric versions developed for protection of crops from deer and other predators are also available. Wire spacing and electrical designs depend on the kinds of livestock to be contained or predators excluded. High-tensile woven wire fence, originally developed over ten years ago in New Zealand for deer farming, is now being marketed and manufactured in the U.S.

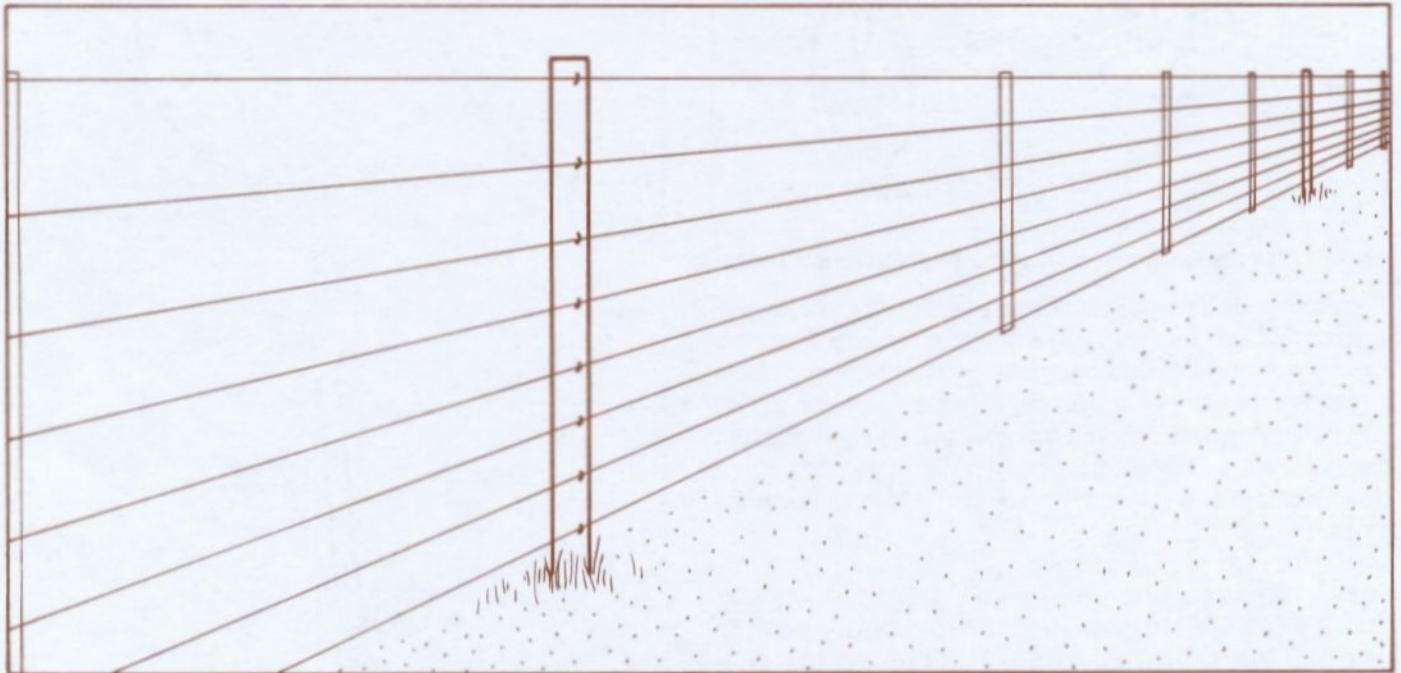

NON-ELECTRIC FENCE CONSTRUCTION

High-tensile wire fencing is no more difficult to erect than other kinds of fencing, but some special pieces of equipment are needed for efficient construction (Figure 1). Because wire strands are stretched to maintain up to 300 pounds of tension, depending on wire gauge, corner and end posts must be sturdy and well-braced. Line posts are smaller than corner and end posts because they mainly serve to hold up the wire and maintain wire spacing. Gate, end, and corner posts are set first.

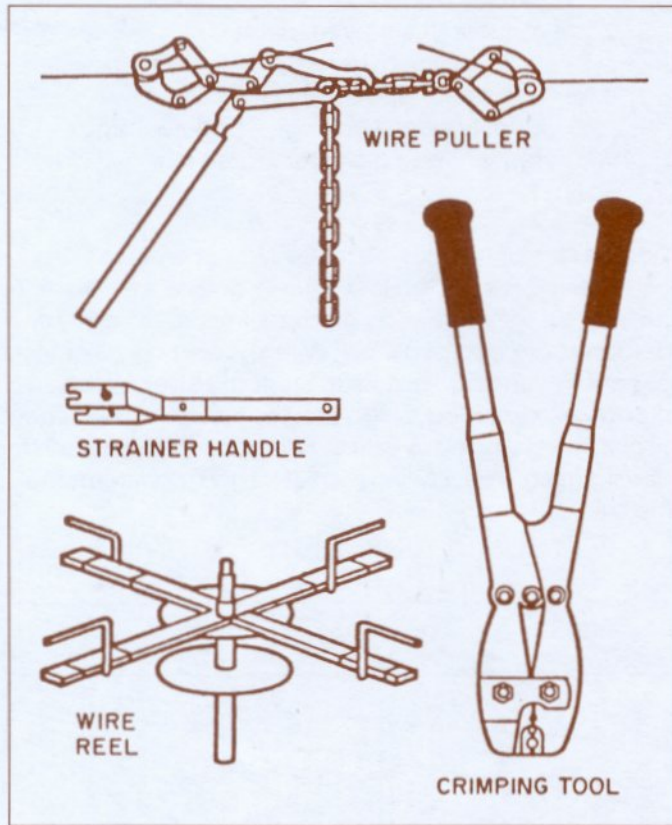

Figure 1. Special Equipment for Constructing High Tensile Fence

Recommended corner and bend assemblies are shown in Figures 2, 3, and 4. Posts are set with a mechanical post driver in an auger-drilled pilot hole, although in some cases posts are set without a pilot hole. Table 1 lists the auger diameters needed to set posts of various sizes. Posts can also be hand-set in hand-dug holes, but driven posts have initially about five times the holding strength of hand-set posts.

High-tensile wire is packaged in various size coils ranging from 2,160 to 5,000 feet. Wires can be run from the coil one wire at a time using a spinning jenny, or several at a time using a multiple-wire fencer. The bottom wire should be

Table 1. Auger Diameter for Different Size Posts

POST SIZE DIAMETER	AUGER DIAMETER
3"-4" (75-100mm)	3" (75mm)
4"-5" (100-125mm)	4" (100mm)
5"-6" (125-150mm)	5" (126mm)
6"-7" (150-175mm)	6" (150mm)

installed first as a guide for setting line posts. Wires are secured to end, corner, or gate brace posts with crimping sleeves or with appropriate knots. Table 2 at the end of this section provides specifications for non-electric high-tensile wire fences.

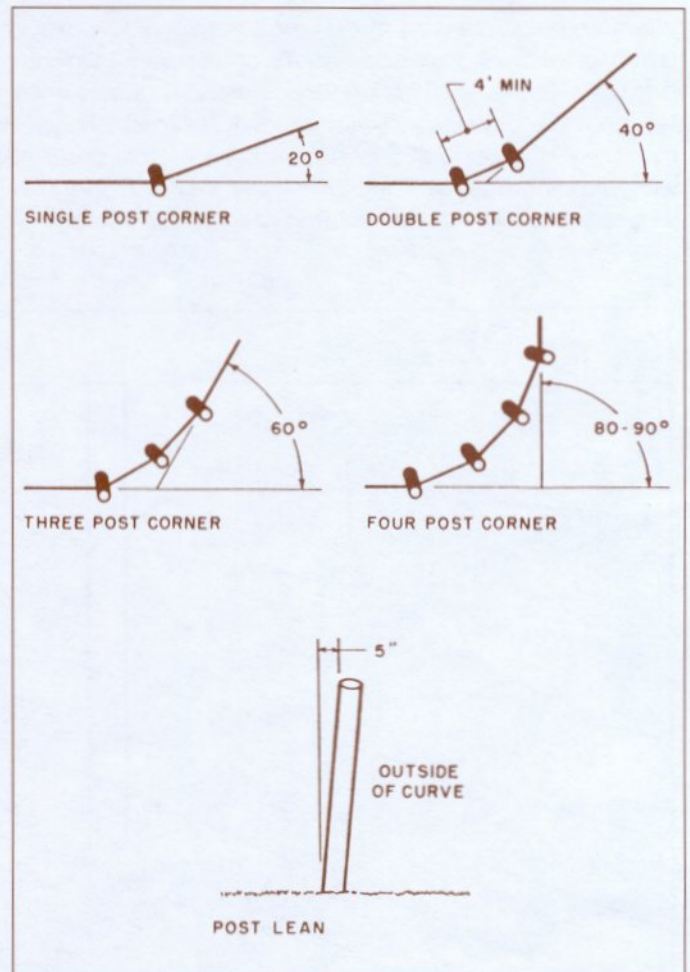
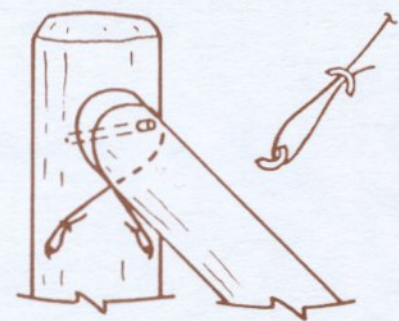
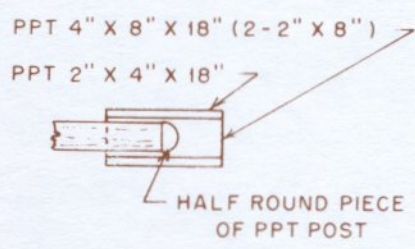

Figure 2. Corner Constructed with Posts Leaned



SAFETY WIRE & PIN ASSEMBLY



TOP VIEW

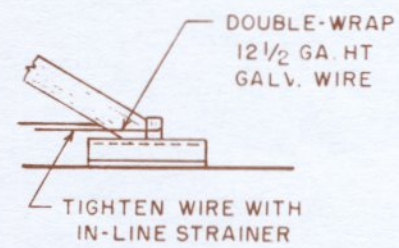

BRACE BLOCK OPTION

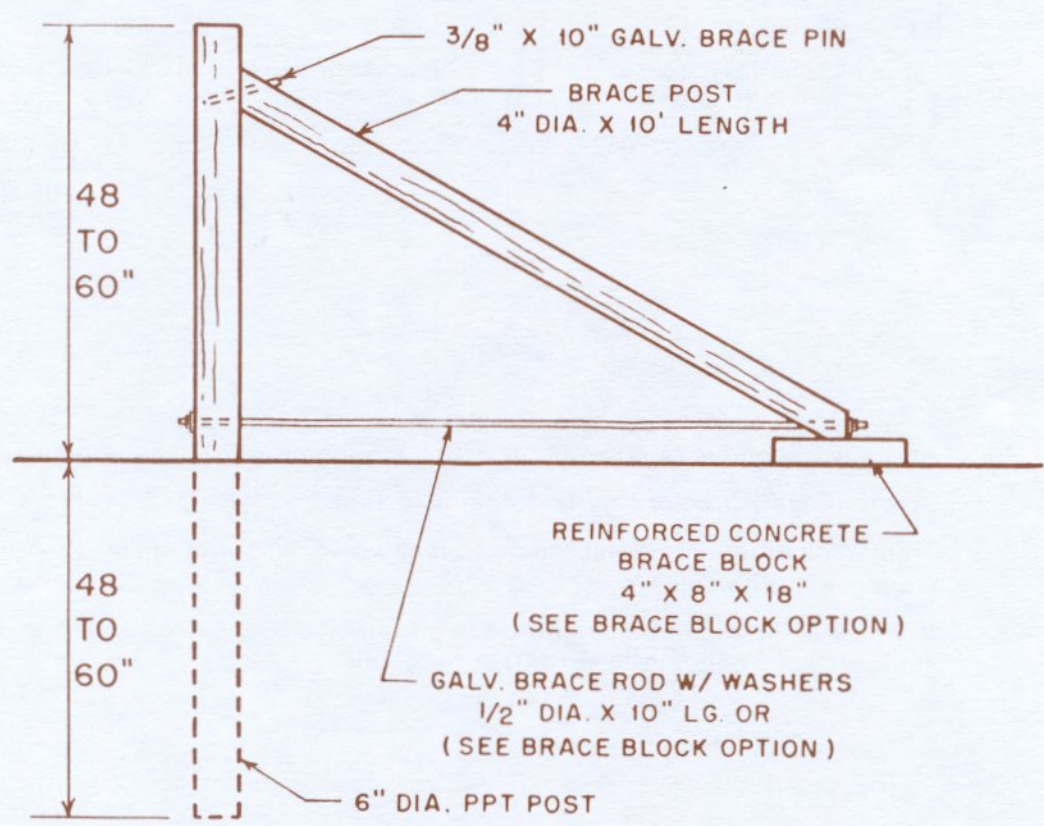
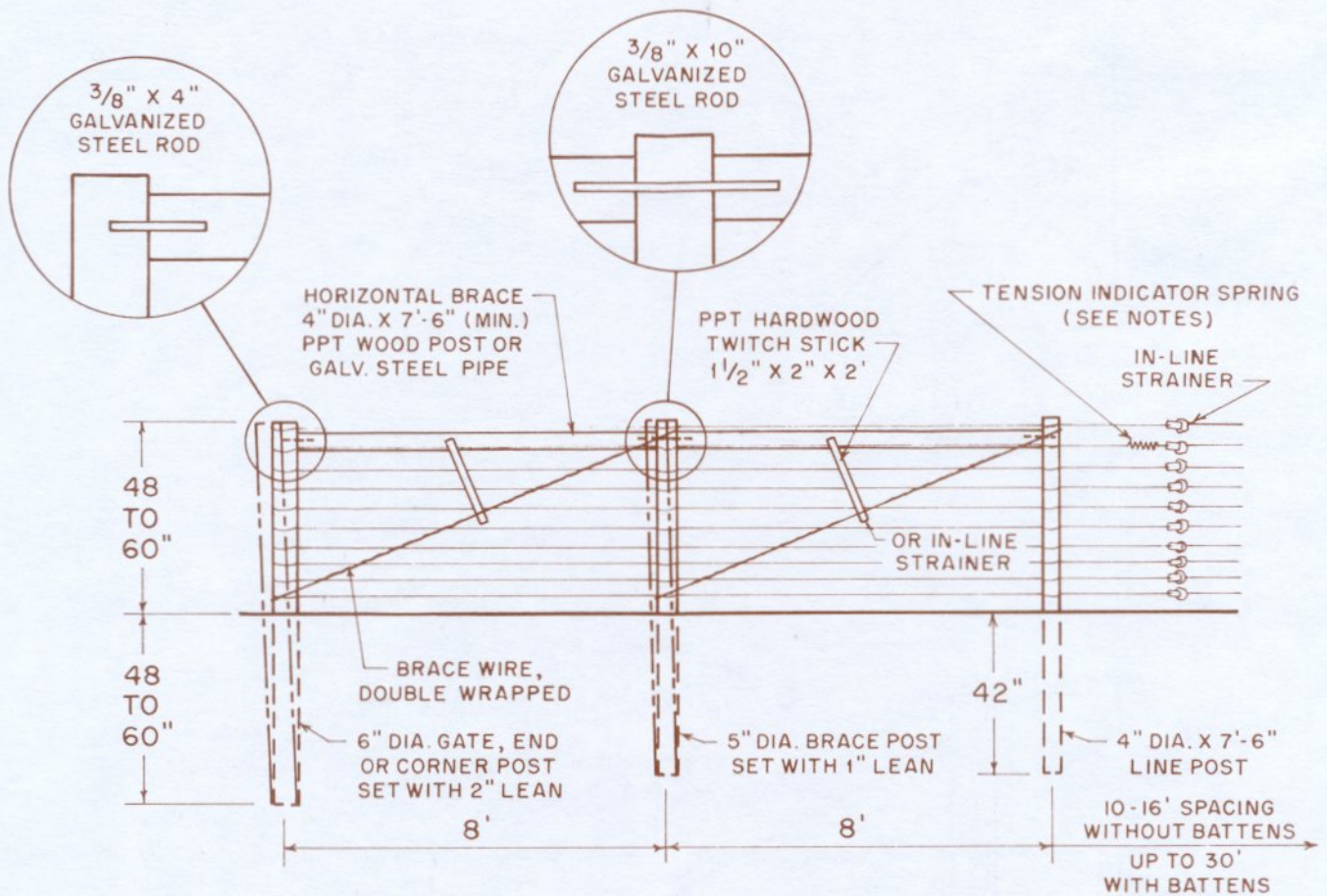

Figure 3. Diagonal Brace Assembly for Ends and Corners Preferred in Rocky or Hard Soil



- NOTES :
- Brace wires and wire strands to be 12 1/2 gauge high-tensile galvanized.
 - Stretch extension springs to obtain wire tension of 250 - 300 lbs.
 - Tighten all other wires, according to tension on wire with spring, by feeling with the fingers.
 - 8 wires or less can be single brace panel with triple wrap brace wire in stable soil, especially with 10' brace rail.

Figure 4. Double Brace Assembly for Gate, End or Corners

STAPLES

Staple pull-out is a common fencing failure when softwood posts are used. Pull-out can be reduced by selecting 1 3/4-inch or 2-inch, 8 or 9 gauge hot-dip galvanized staples with slash cut points and barbs, if available. Shorter staples with single legs or diamond points don't have enough holding power in softwood, although shorter staples are acceptable for hardwood posts.

String the wires on the inside of the posts or on the outside of curves. Drive staples slightly off the vertical so they straddle the wood grain, as shown in Figure 5. The staples should allow wires to move back and forth freely. Rotate the staples about 25 or more degrees from the flat surface of the point as shown in Figure 5. This practice spreads the legs for greater holding power. Drive staples at an upward angle into posts in dips and at downward angles into posts on rises.

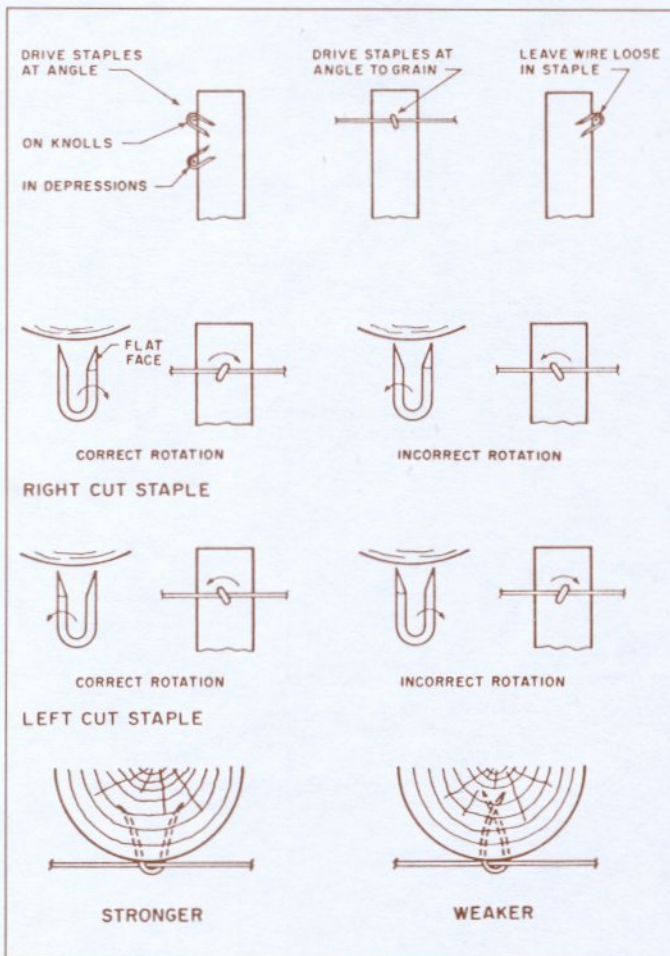

Figure 5. Proper Stapling

TENSIONING WIRE

Wear heavy leather gloves and eye protection when tensioning wire. Apply recommended tension up to 300 pounds to each wire with a ratchet in-line strainer or tightener. The in-line strainer also permits seasonal

adjustment of the wires for temperature changes, if necessary. A tension indicator spring is used to obtain the proper wire tension on one wire (Figure 6). Then, all other wires are tightened by feel to match the tension on the wire with the spring. Tightener locations for different fence configurations are shown in Figure 7.

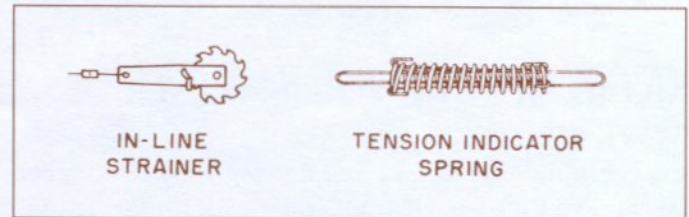

Figure 6. Wire Tensioning Equipment

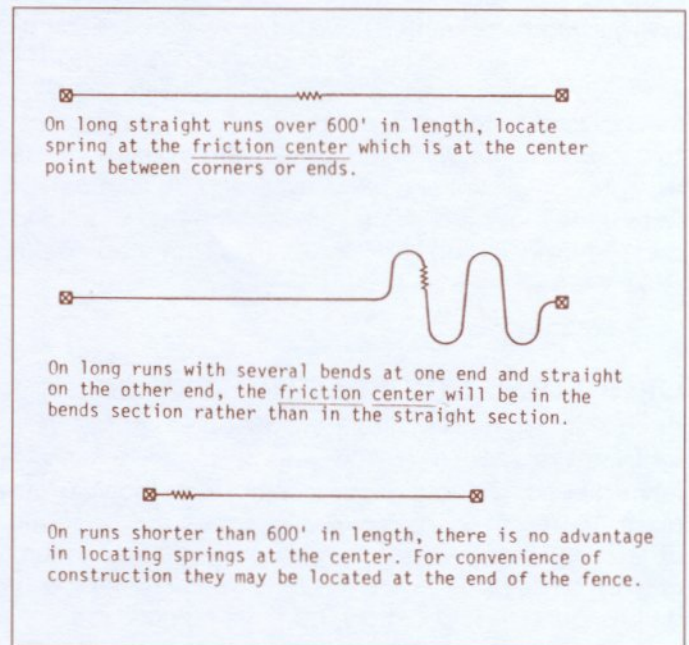

Figure 7. Tension Spring Location for Different Fence Conditions

WIRE SPACERS

Pressure treated hardwood battens or fiber glass posts are often used on level terrain to maintain wire spacing in place of the more expensive line posts. The angle-groove batten is made to hold the wire in place without clips. Straight-groove battens require the use of preformed or cut-on-the-job wire clips. Battens, fiber glass posts, and clips are shown in Figure 8.

Problems with wood battens include notches that are too shallow and allow wires to move to a different notch, or notches that do not allow wires to slide back and forth freely, which causes the batten to be pulled to a non-vertical position when pressure is applied to one or two wires, and makes wires difficult to retighten and susceptible to breaking. Extra long, light duty hardwood posts with pointed ends driven 18-21" into the ground may be used instead of battens. These posts are used in permanent

fences or reused in temporary fences, particularly electric ones. Light duty (LD) or heavy duty (HD) fiber glass T-posts, while not as rigid as hardwood battens, may either be set in or suspended above the ground. If battens or fiber glass posts are used on uneven ground, they should be anchored to maintain fence system integrity. Figure 9 shows post and batten spacing and anchoring on uneven ground.

MECHANICAL FASTENERS VERSUS WIRE KNOTS

Knots are an economical and convenient way to splice wires and attach them to posts. The knots shown in Figure 10 are completely satisfactory if tied properly. Many other knots slip or break below the practical working strength of the wire. Most wire knotters have adopted the clean break method, which requires no tools and leaves no sharp edges.

Mechanical fasteners, such as crimping sleeves, wire anchors, and other wire fasteners, are often used because they are convenient and preferred over knots for more stiff wires. They provide a simple, efficient method of splicing and fastening. If properly installed, these fasteners do not slip or weaken the wire.

GROUNDING NON-ELECTRIC FENCE

All non-electric fencing must be grounded for safety from lightning. Tie all wires (five wraps) with galvanized wire ties to fence grounding electrodes spaced not more than 300 feet apart (150 feet in dry, rocky soil). Electrodes must be driven at least three feet deep. They must be either standard galvanized steel post, new 3/4-inch galvanized steel pipe, or a UL (Underwriters Laboratory) approved ground rod.

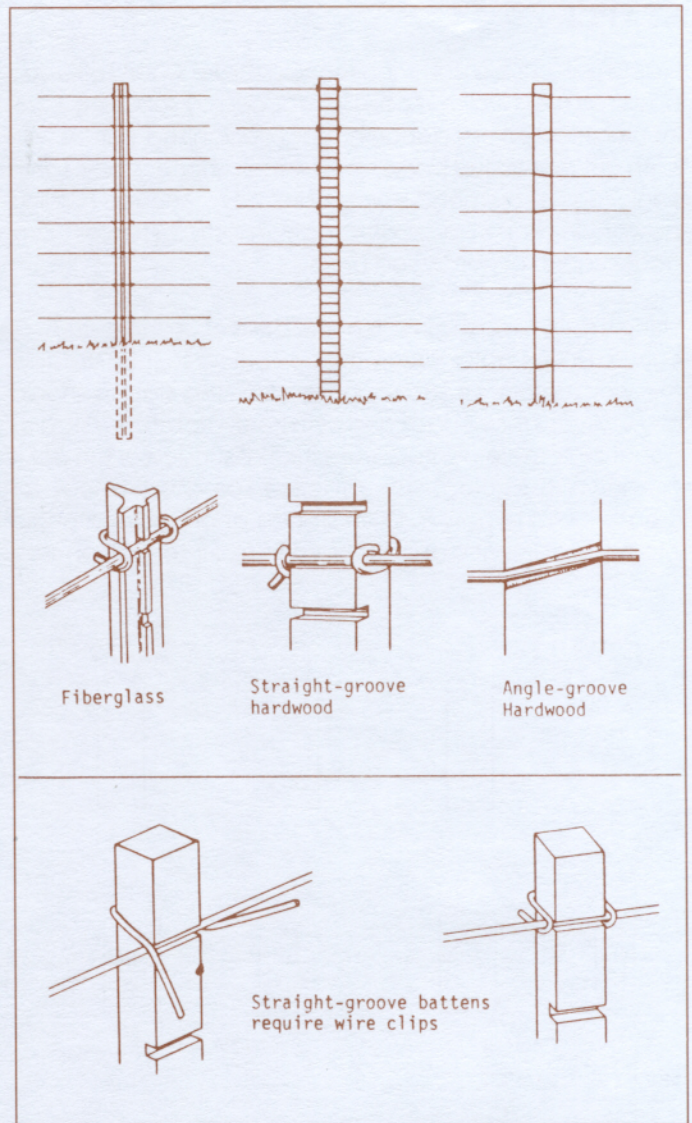

Figure 8. Types of Battens

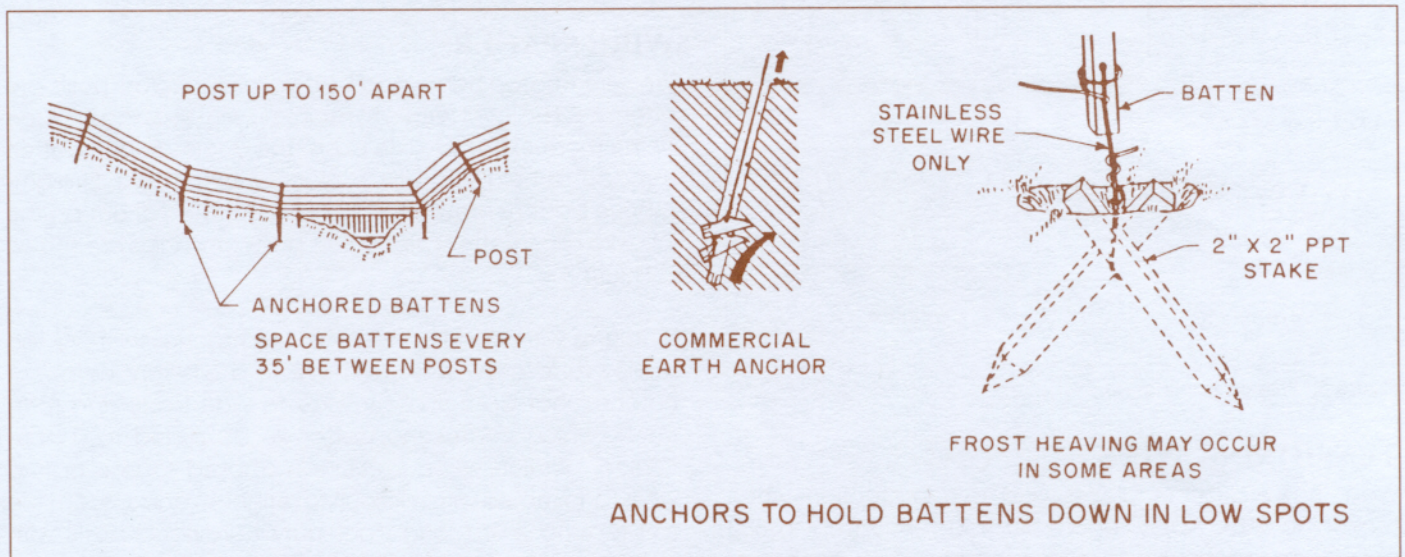

Figure 9. Batten Spacing and Anchoring for Uneven Ground

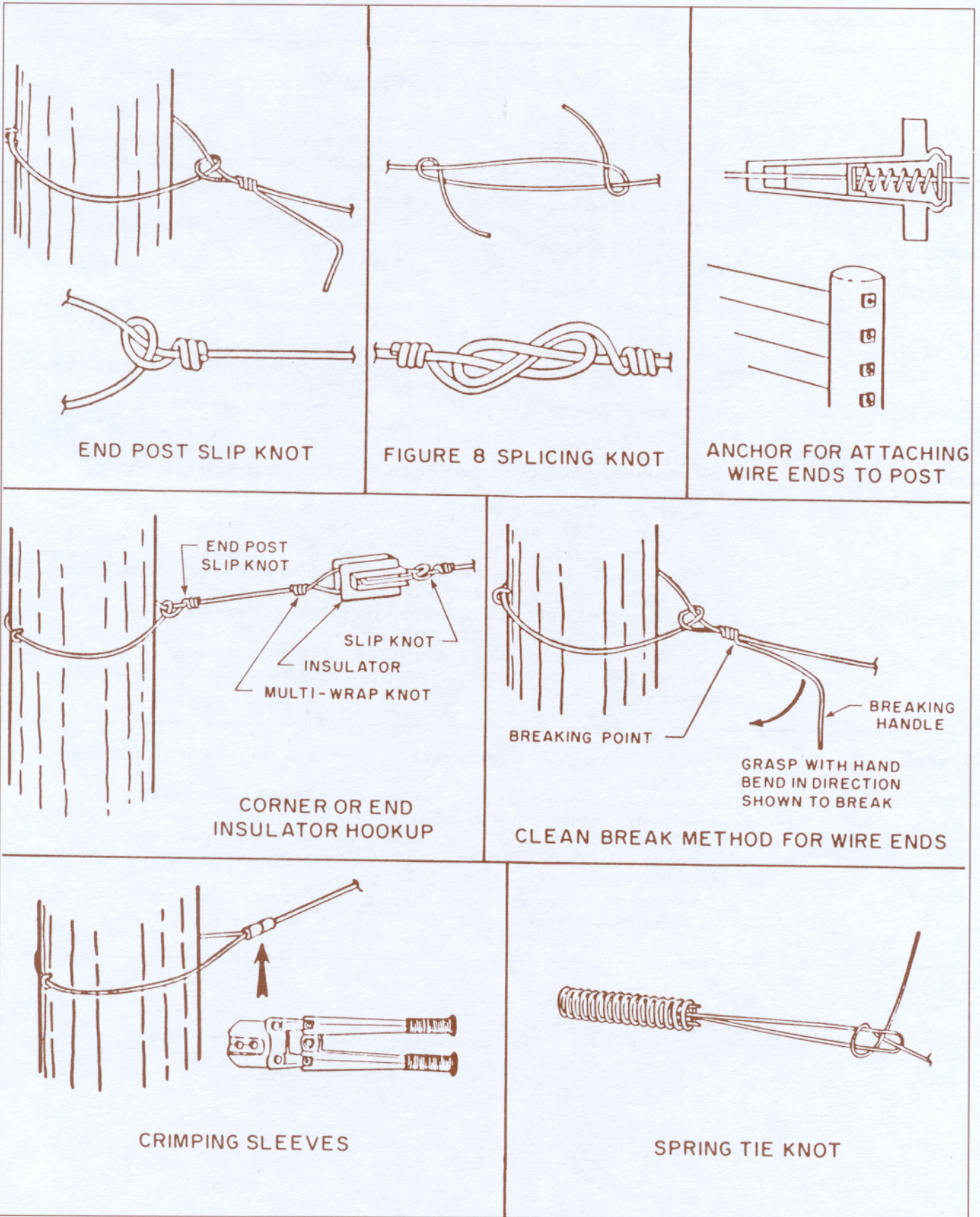

Figure 10. Wire Connections

Table 2. Specifications for Non-Electric Fence

	DIMENSIONS	INSTALLATION
POSTS		
Corner or gate posts	6" - 7" dia. x 8' long	Set 4' deep.
Line posts	4" dia. x 6 1/2' long	Set 2 1/2' deep. Space 10' - 16'. Increase spacing to 30' if battens are used between posts.
BRACING		
Double brace posts	5" - 6" dia. x 7 1/2' - 8' long	Set 3 1/2' - 4' deep.
Horizontal brace rail	4" - 5" dia. x 7 1/2' - 8' long	Place near post tops between top 2 wires.
Brace post pins	3/8" x 10" and 3/8" x 4" galvanized steel rods	
Brace wire	12 1/2 gauge high-tensile wire, Class 3 galvanized	Horizontal brace (Figure 4). Double-wrap, tighten with 1 1/2" x 2" x 2' hardwood twitch stick or in-line strainer.
Brace rod	1/2" dia. x 8' - 10' long galvanized steel	Diagonal brace (Figure 3). Thread through bottom of end post and brace on top of floating foot.
Alternate brace wire	12 1/2 gauge HT wire, Class 3 galvanized	Double-wrap, tighten with in-line strainer (See Figure 3).
WIRE		
TYPE:	12 1/2 gauge high-tensile galvanized, minimum 1300 pounds breaking strength.	
SPACING:	From ground to top wire - Ten-strand livestock fence: 4", 4", 4", 4", 5", 5", 5", 5", 5", 5", (46") Ten-strand cattle feedlot fence: 10", 4", 4", 4", 5", 5", 5", 5", 5", 5", (52") Eight-strand sheep and cattle fence: 4", 5", 5", 5", 6", 6", 7", 8", (46")	
TENSION:	250 - 300 pounds each wire. Tension with in-line wire strainers. Install a tension indicator spring on at least one wire to gauge wire tension.	
FASTENING:	At gate, corner, and end braces, use appropriate knots or crimping sleeves or wire anchor through posts. Staple wires to posts with 1 3/4" or 2" x 8 or 9 gauge galvanized staples with slash cut points. Do not drive staples tight in line posts. Angle staples to prevent post splits. Drive into post at downward angle on knolls and at an upward angle in depressions.	
NOTES:		
1) Variations in design detail and structural components using six to ten or more strands are possible.		
2) All posts are pressure treated softwood or locust. Use either rounds or equivalent sawn posts. Double brace end assemblies shown in Figure 4 (three posts, two horizontal rails) are recommended to accommodate longer runs of ten-strand fence. A 10' single brace (two posts, one horizontal rail) end assembly may be adequate for eight-strand or less in heavy soil.		
3) Corners and bends may be constructed without braces by close spacing and "leaning" posts as shown in Figure 2.		

ELECTRIC FENCE

Permanent electric fence with up to five strands is suitable for holding sheep, hogs, goats, cattle, and horses. It can be constructed with high-tensile wire and various types of PPT pine or locust, creosote pressure treated hardwood, or fiber glass posts and battens for about half the material and labor cost of an equivalent woven wire fence. While electric fence has always been economical to install, maintenance has been a problem. Innovations in fence charger design and fence construction now make long runs of electric fence feasible in regard to maintenance.

Generally, the construction methods described for non-electric fence also apply to electric fences, with one important exception. Energized wires must be insulated from posts and battens, except for selected posts of pressure creosoted dry hardwood (see notes in Figure 12) or fiber glass. Methods for accomplishing this insulation are shown in Figure 11. In Figure 12, details of a permanent electric livestock fence with horizontal braces are shown. Table 3 at the end of the section provides specifications for permanent electric fence.

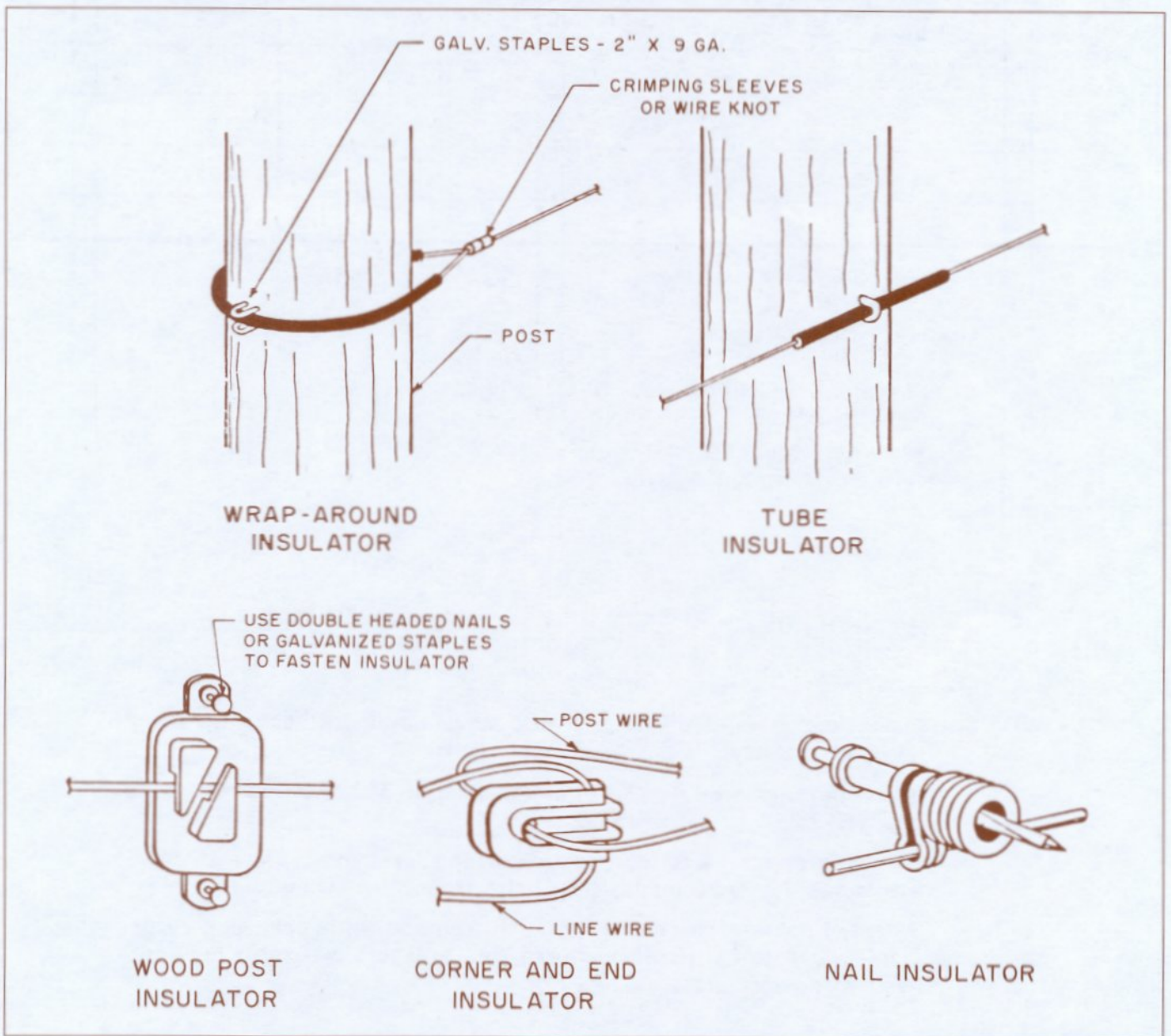
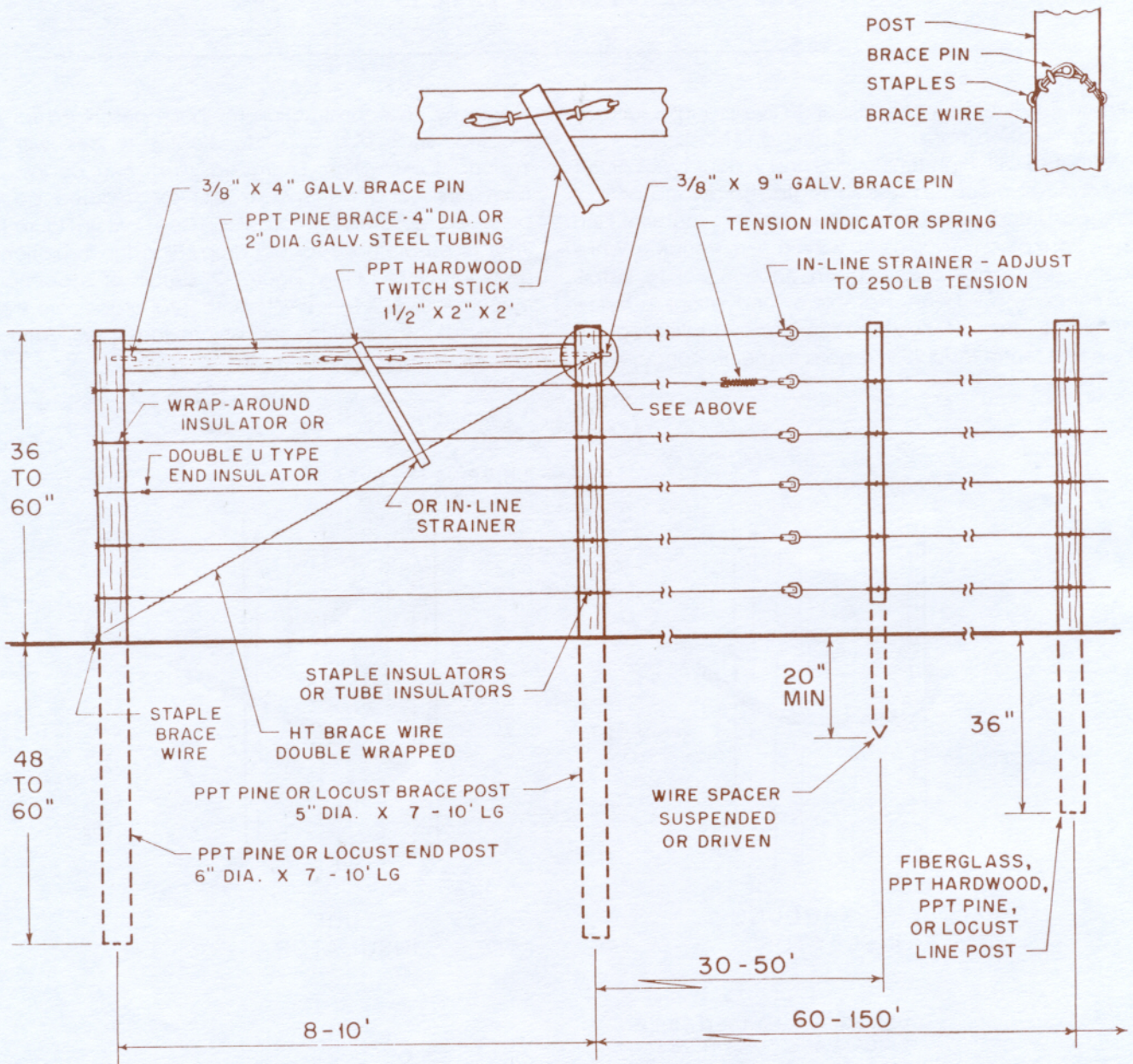

Figure 11. Types of wire insulators



NOTES: Install line posts on all rises or at a maximum of 150' apart on smooth, level terrain only.

Install battens in all dips or at a maximum of 30' apart for 5 strands and 50' for 2 or 3 strands.

Two or three strand for cattle; five strand for sheep; three strand with wires 7, 17, 28 inches above the ground for swine.

Selected posts of dry hardwood (ash, red and white oak, hickory or maple dried to 14 - 16 % moisture) and pressure creosoted may be used without insulators.

Figure 12. Brace Assembly for Permanent Electric Fence for Livestock

ENERGIZERS

Voltage must be maintained at all times if an electric fence is to be effective. In the past, electric fencing was limited because it was impossible to energize long runs. A variety of new low impedance, high voltage energizers, sometimes called chargers, utilizes technological advances in electronics and can electrify long permanent fences without losing significant voltage, nor will they set on fire any grass contacting the wires.

The energizers produce a very short, 0.003 second, high energy pulse. The high energy level of the pulse charges even a long length of heavily weeded fence with a shock that livestock respect. The short pulse limits the overall energy, so posts are not burned and the wires are safe, though painful, to touch. Both battery and plug-in units are available in several models adequate for short runs, and ultra power models are available which are capable of maintaining high energy output for up to 50 miles of fence wire. Some models have selector switches to slow the pulse rate from 65 to 45 pulses per minute. A high frequency is needed to train animals, which can be reduced to extend battery life after training is completed. For deer fences, however, maximum pulse rates should be maintained continuously so new, transient, and starved deer will be deterred. Heavy duty batteries that are designed to withstand a deep discharge before recharging are recommended.

GROUNDING

Grounding is very important with these energizers. Three, four, or more separate ground rods six feet long and six feet

apart may be required also. An existing culvert, buried pipe, or metal object also may be used. Never use an existing household ground rod.

Electrified fence wires should not be installed beneath overhead power lines. Electrified barbed wire is dangerous, since animals or children can become entangled and be repeatedly shocked, sometimes to death.

IDENTIFY ELECTRIC FENCES

Although the brief duration of the electrical pulse of this fence makes it suitable for use near humans and livestock, all electric fences should be identified with signs at every 200 feet. In most states, this is required by law, but even if it is not required in your state, it is good practice. Electric fences, particularly near highways, are preferred more for internal rather than boundary fences.

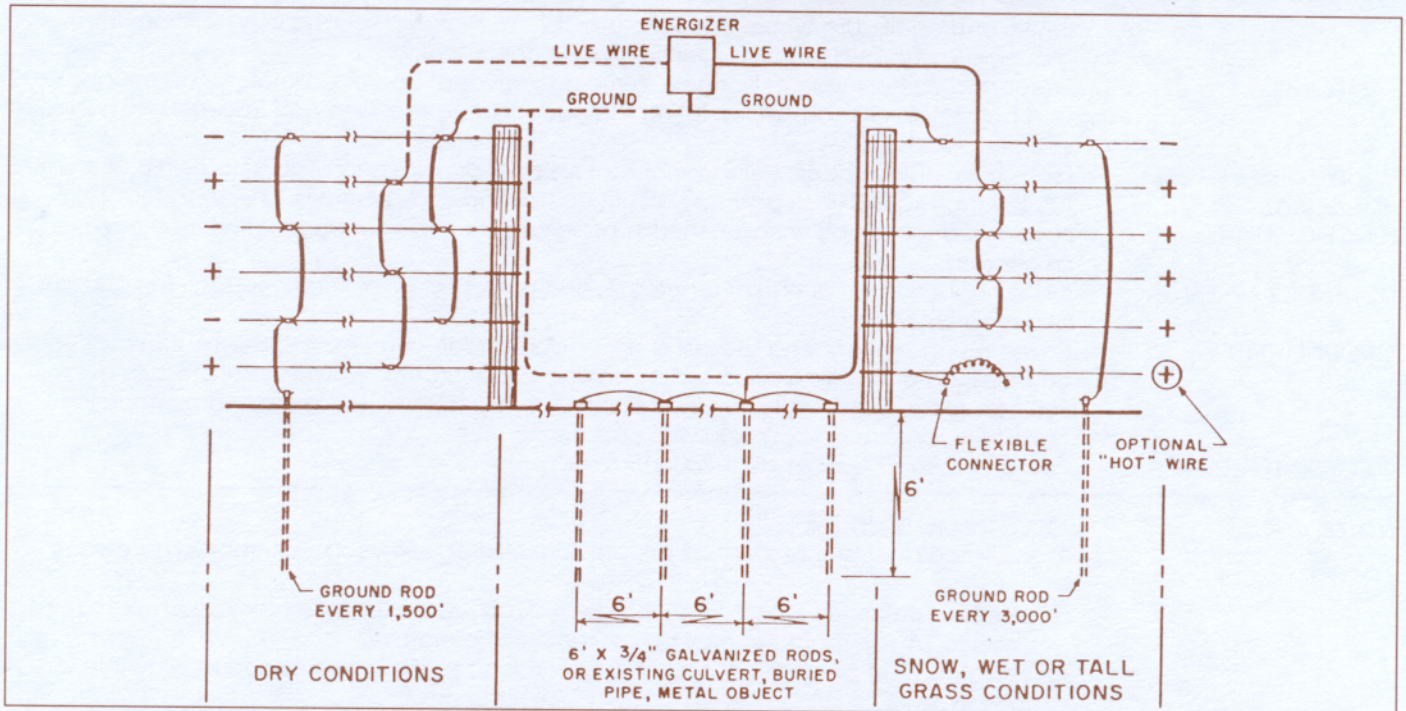

Figure 13. Grounding and Electrical Connections for Different Conditions

Table 3. Specifications for Permanent Electric Fence

	DIMENSIONS	INSTALLATION
POSTS		
End or corner posts	5" - 6" dia. x 8' long pressure treated (PT) pine or locust.	Set 4' deep with 2" lean
Line posts	5' x 2" x 1 1/2" self-insulating notched wooden or HD fiber glass posts.	Set 2' deep on all rises, max. spacing 150', set perpendicular to the ground.
Battens	40" - 48" x 1 1/2" x 1" self-insulating notched wooden, or 4' - 5' long fiber glass posts.	Install in all depressions. Max. spacing 30' for 5 strands. 50' for 2 or 3 strands. Hold-downs required in depressions. (see Figure 9)
BRACING		
Brace posts	4" - 5" dia. x 8' long PT pine or locust	Set 4' - 5' deep.
Brace rail	2" dia. x 8 - 10' galvanized steel tubing or 4" - 5" dia. x 8' - 10' long PT pine.	Install near top of posts, between top 2 wires.
Brace pins	Galvanized 3/8" dia. steel rod, 10" and 4" lengths.	Pin brace rail to posts (see Figure 12).
Brace wire	12 1/2 gauge high tensile (HT), Class 3 galvanized.	Horizontal brace (Figure 12) - Double wrap, tighten with twitch stick or in-line strainer.
Batten anchors	24" x 1/2" x 1 1/2" PT wood or other earth anchor	Use for batten hold downs in dips or uneven terrain.
Brace rod	1/2" dia. 8' - 10' long galvanized steel	Diagonal brace (Figure 3) - Thread through bottom of end post and brace on top of floating foot.
Alternate brace wire	12 1/2 gauge, HT wire, Class 3 galvanized	Double-wrap, tighten with in-line strainer (see Figure 3).
WIRE		
TYPE:	12 1/2 or 14 gauge HT galvanized fence wire, minimum 1,000 pounds breaking strength.	
TENSION:	200 - 250 pounds. Tension with in-line wire strainers. Install a tension indicator spring on one wire to gauge wire tension.	
SPACING:	One-strand: 30" above ground (for milking cows). Two-strand: wires at 17" - 24" and 38" above ground (for cows and calves, horses and foals). Three-strand: wires at 17", 27", 38" above ground (for hard to hold cattle). Three-strand: wires at 11, 17, 28" above ground (for hogs). Five-strand: wires at 5", 10", 17", 27", 38" above ground (boundary fence for sheep, lambs and cattle. Use where dogs are a problem). First and second wires up from the ground are charged or not, depending upon the conditions.	
FASTENING:	Preformed corner insulator hangers, crimping sleeves or approved knots for corner and end posts. Wire clips on self-insulating line posts and battens, line post insulators for non-self-insulating posts.	
INSULATORS: (if needed)	High density black plastic, ultra-violet light resistant or extra heavy duty porcelain, line wire tube, wrap-around tube galv steel insert, corner and end double-U, nail-on (Figure 11).	
FENCE CHARGER:	Low impedance, high voltage, short impulse type. Select to change length of fence as needed.	
LIGHTNING ARRESTOR:	Install near charger, at end of fence line, and at highest point in fence. Lightning choke is also recommended.	
GROUND RETURN:	Driven ground rods 6' long at least 6' apart, buried pipe or an existing metal object at each energizer, total length as specified by energizer manufacturer. Additional grounds every 3000' for snow, wet, or tall grass conditions, or every 1500' for dry areas or prolonged ice conditions on alternating earth wire systems	
ELECTRIC FENCE SIGNS:	Post on fence at least at 150' - 200' intervals.	
NOTES:		
	1) Variations are possible.	
	2) Insulators must be used if posts are pressure treated softwood, salt-treated hardwood or locust.	
	3) Selected pressure creosoted dry hardwood (ash, red and white oak, hickory or maple dried to 14-16% moisture) may be used without insulators.	
	4) Insulators must be strong enough to support long spans of wire and must allow the wire to slide freely.	

LIGHTWEIGHT HIGH-TENSILE FENCE

Recent interest in pasture management involving intensive or controlled grazing systems has created a need for semi-permanent or temporary sub-division fence systems. These allow forage growth, quick grazing, animal removal to other plots, and regrowth of forage for future grazing. One such fencing system recently introduced in this country from New Zealand utilizes lightweight (16 gauge) high-tensile smooth wire. This "spider" electric fence system wire is Class 3 zinc-galvanized steel with a breaking strength about one-third that of 12 1/2 gauge high-tensile wire. Spider wire is only suitable for fence designs specially tailored for it.

Pressure preservative treated wood posts are used for ends, corners, and gate openings, and fiber glass rods are used for

line posts. Bracing is not required, since the wire is only tensioned to 25-30 pounds. As shown below in Figure 14, a spring-steel G-spring is used as a wire tensioner, as a cut-out switch, and as a gate hook to create gateways which are integral to the fence. Line wires are attached to the fiber glass line posts with double wedge clips of high quality plastic, stainless steel connector clips, or other types of connectors. The wire can be recoiled and moved to different locations.

Additional information on fencing systems, materials and methods for intensive grazing systems can be obtained from fencing suppliers.

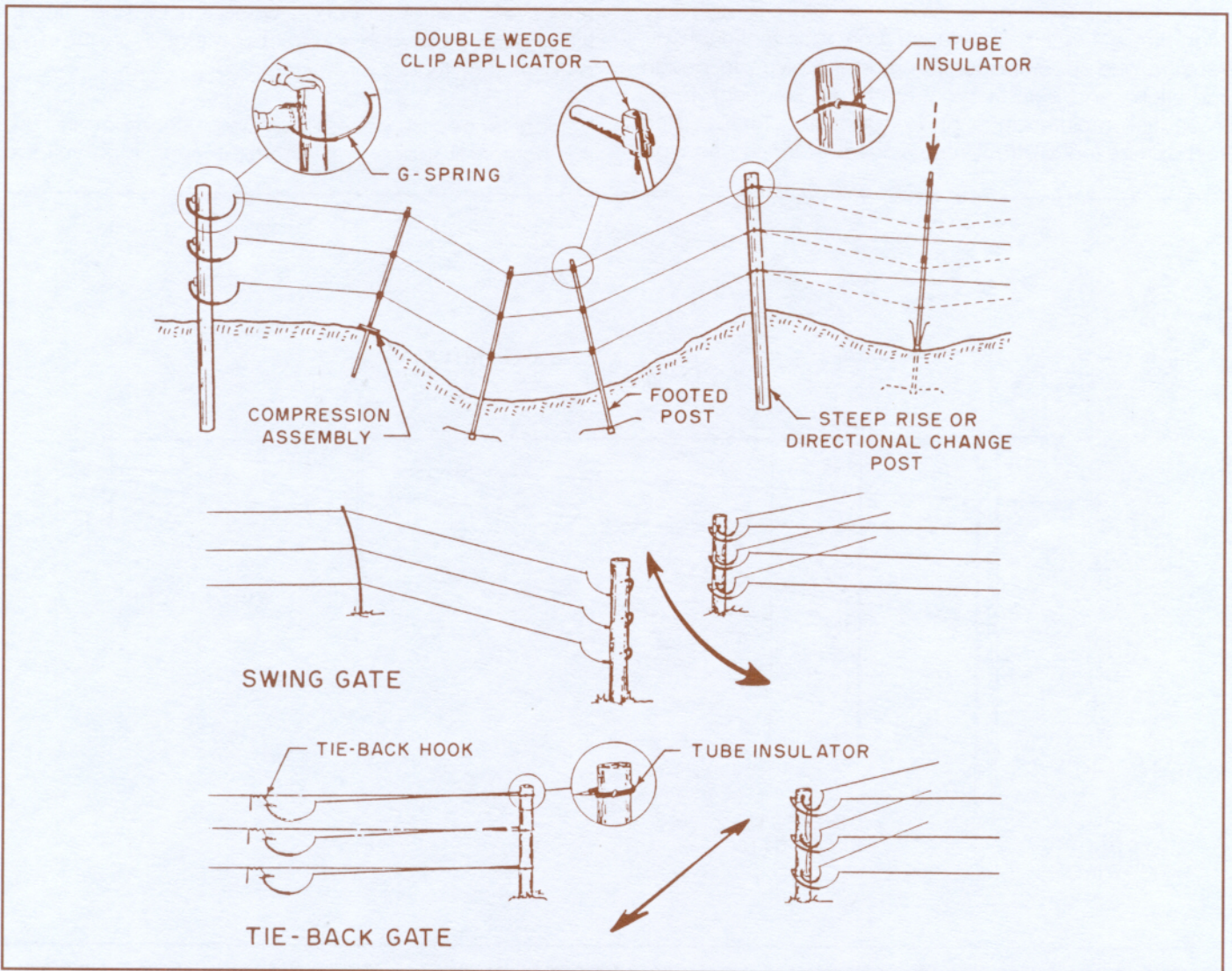

Figure 14. Lightweight High-Tensile Fence for Intensive Grazing Systems

HIGH-TENSILE FENCING FOR DEER CONTROL

Various high-tensile wire electric and non-electric fence designs can be effectively used to protect agricultural crops from white-tailed deer damage. Designs utilizing lightweight fiber glass posts and electrified poly wire rather than high-tensile wire are available for home gardens. These temporary fences have been satisfactory in most situations during recent tests. Survey data from Northeast fence owners indicates that vertical fences are most often used on small acreages (10 acres or less) and on short rotation crops, while slanted fences are more widely applied to large acreages or long rotation crops. Non-electric woven wire fence has application where deer ingress cannot be tolerated at all or on very large acreages (100 acres or more), where maintenance for electric fences would be difficult.

High-tensile fencing is different from conventional wire fencing and special attention must be given to design, materials, and construction methods. Frequent fence inspection, maintenance, and vegetation control is critical to maximize fence effectiveness. Several fence designs are

illustrated in this section following a brief discussion of each type. More detailed construction methods for these designs are available in West Virginia University Cooperative Extension Service Publications 812, 814, and 816.

VERTICAL FENCE

Vertical high-tensile electric anti-deer fences of six or more wires appear to be effective in controlling deer in most situations (Table 4, Figure 15). These designs are a modified version of the Penn State 5-wire, 58-inch vertical fence with closer wire spacings. Vertical fence wire spaces should be no greater than 8 inches from the ground for the first wire and no more than 10 inches between the remaining wires. Modifications of vertical fences to include additional lower wires at 5, 10, and 15 inches above the ground will effectively control raccoons, woodchucks, and rabbits. Bracing assemblies and construction methods are the same as for electric fences for livestock.

Vertical fences are generally simple to construct and use less horizontal space than slanted fences. High voltage

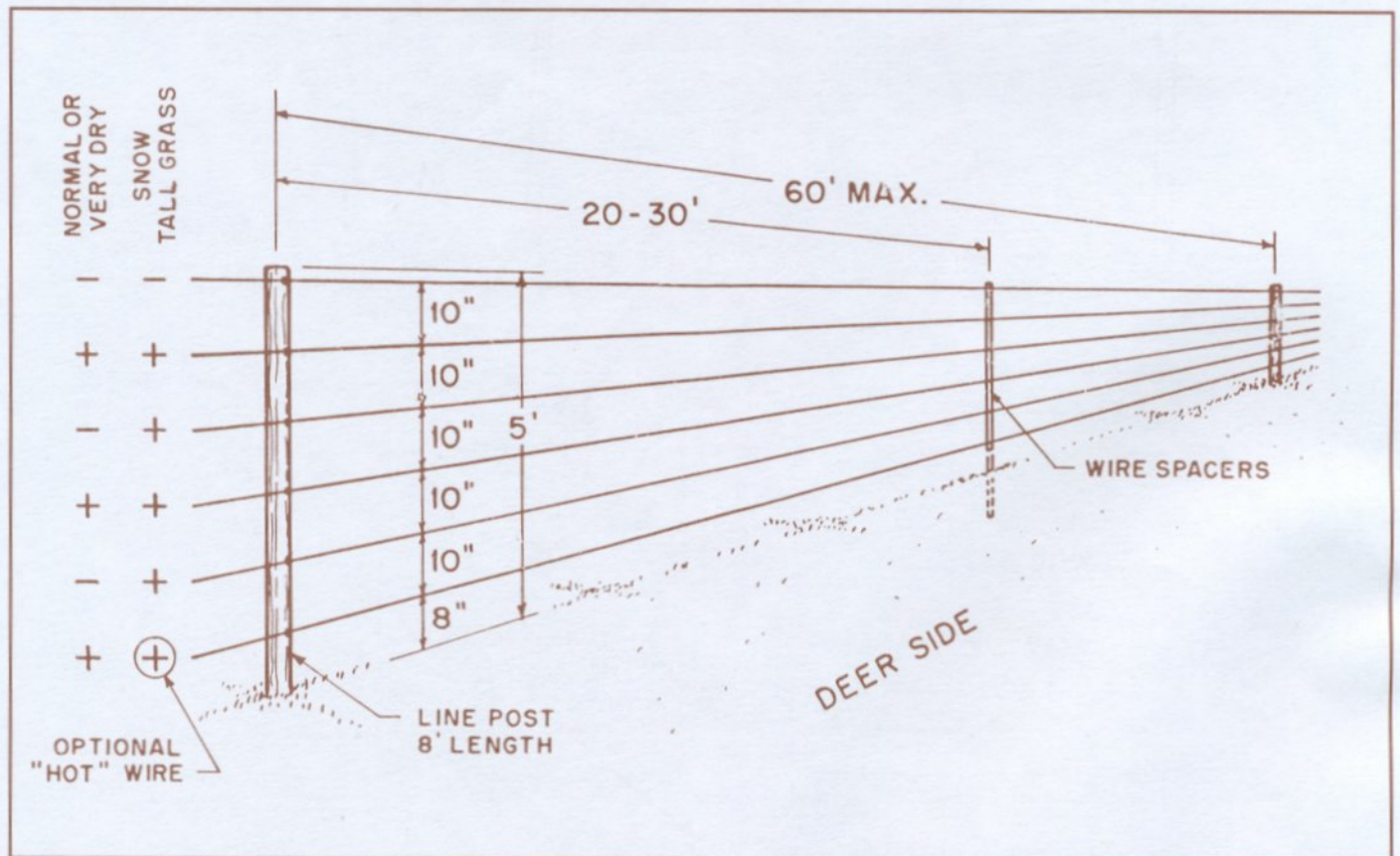

Figure 15. 6-Wire Vertical High-Tensile Electric Anti-Deer Fence. Additional Lower Wires at 5, 10, 15-inch Spacing Above Ground Will Effectively Control Raccoons, Woodchucks and Rabbits

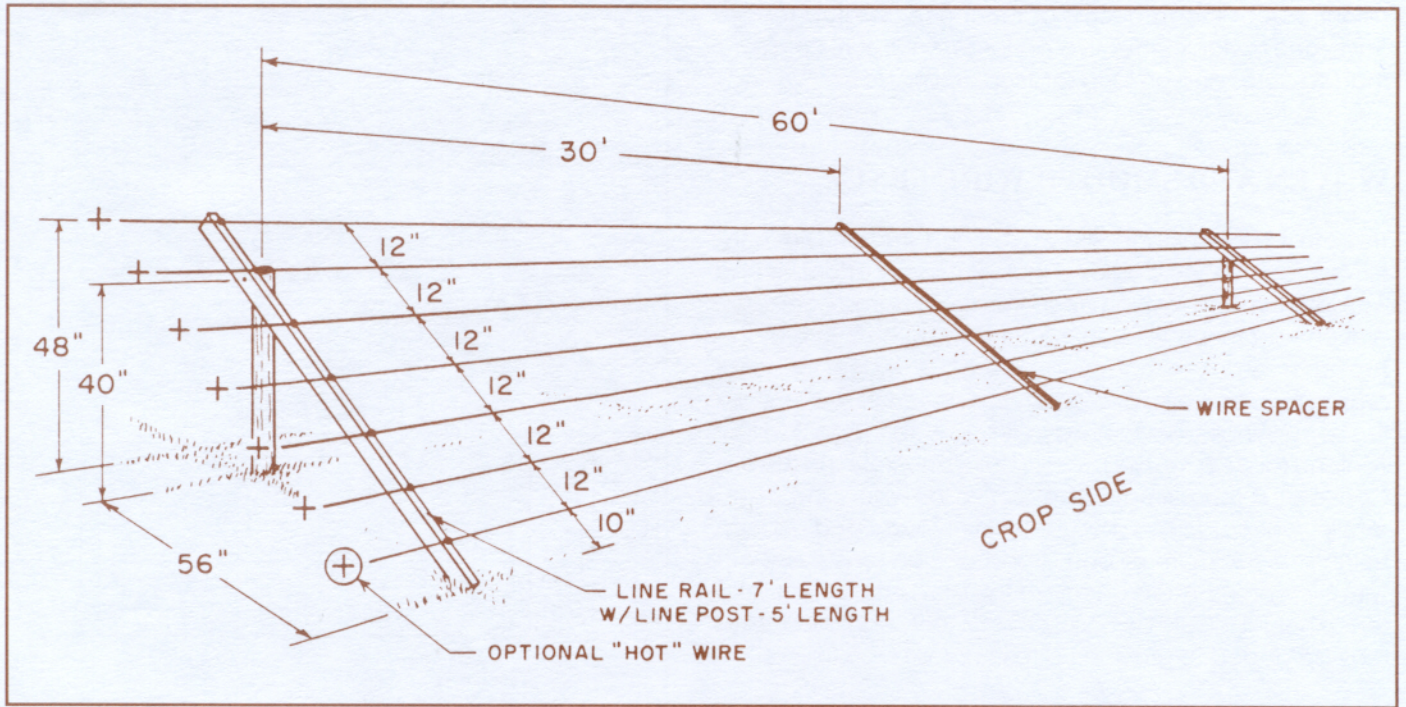

Figure 16. Slanted High-Tensile Anti-Deer Fence. Wires Added Between the Ground and First and Second Wires Provide Additional Small Animal Control

energizers with various capacities electrify short to very long runs of properly constructed and maintained fence. To provide the most effective shock when snow cover, tall grass, or very dry conditions reduce voltage, hot and ground return wire sequence can be changed with a switching device. Vegetation should be controlled in a 12 to 18-inch strip under the fence with herbicides. Vegetation control along the fence also makes fence inspection easier.

Total costs will include materials, labor, and equipment; the cost per foot will vary according to the terrain, line

preparation, and size of the enclosure. Materials will average around 60% of the total cost of the fence. Vertical fences will be most economical and effective when used on small plots of less than 10 acres and on short rotation crops, particularly where winter damage is not intense.

SLANTED FENCE

The 7-wire slanted high-tensile electric anti-deer fence (Table 5, Figures 16–19) is a two-dimensional barrier built in a slanted outrigger design. All wires are spaced along the slanted rail at 12-inch intervals from the ground on the crop side to a 48-inch height on the deer side. The slanted rails are supported near their tops on driven posts. The fence covers approximately six feet of horizontal space and presents a deer with a perplexing barrier as well as an electric shock upon impact. For additional small animal control, wires can be added between the ground and the first and second wires.

The slanted fence is more difficult to construct than vertical fence. However, the use of energizers and the vegetation control practices for slanted fence should be the same as described for vertical fence, as well as hot wire and ground wire configurations for poor electrical conduction conditions.

Total costs of materials, labor, and equipment for constructing a slanted fence could be as much as 60% higher than for vertical fences. Materials will again average

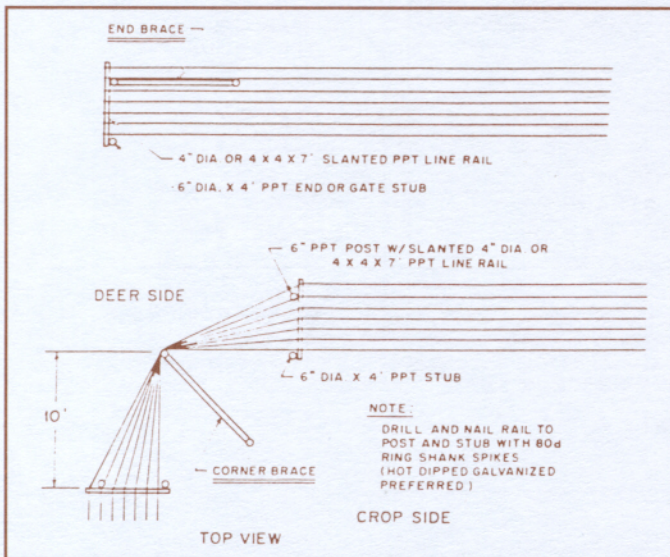

Figure 17. Horizontal Brace Assembly for 7-Wire Slanted Fence Ends and Corners

about 60% of the total cost of the fence. Slanted fences have been widely effective on large enclosures of more than 10 acres and on long rotation crops.

WOVEN AND SMOOTH WIRE FENCE

The 7 to 12-foot high-tensile woven and smooth wire non-electric deer fence (Table 6, Figure 20) is very effective and is recommended for high deer pressure on large acreages. Woven wire fence with out-rigger and barbed wire at the top has been in use many years in the U.S. as deer fence for preserves, parks, and game farms. High-tensile woven wire fence, originally developed over 10 years ago in New Zealand for deer farming, is now being marketed in the U.S. Considered the ultimate in effective deer fencing, high-tensile woven wire is available in 49-inch and 75-inch heights. A minimum of one strand of high-tensile smooth wire is recommended on top of the woven wire and total fence height should be no less than 7 feet. Additional wires may be added to provide up to a 12-foot high fence.

As expected, cost is much higher than for vertical or slanted fence. For a large enclosure (100 or more acres), costs can

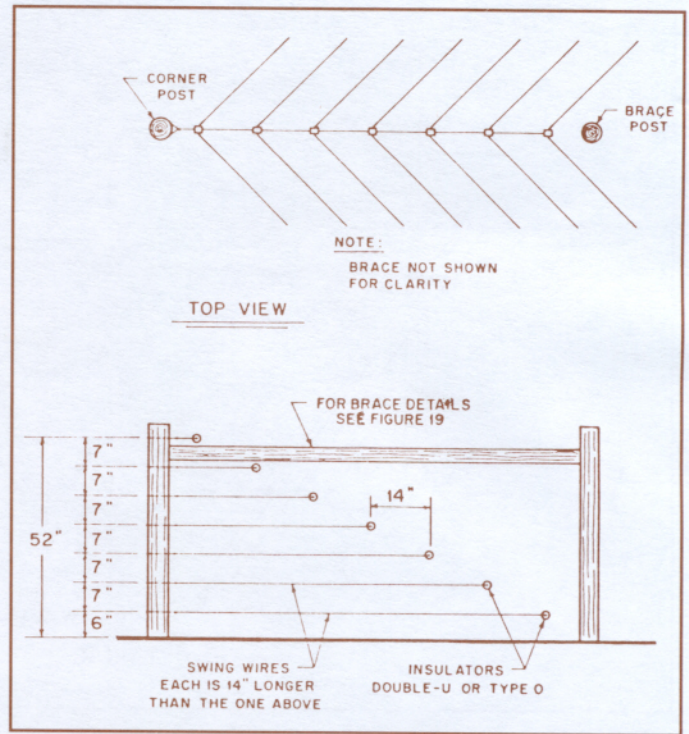

Figure 18. Swing Wire Corner For 7-Wire Slanted Fence

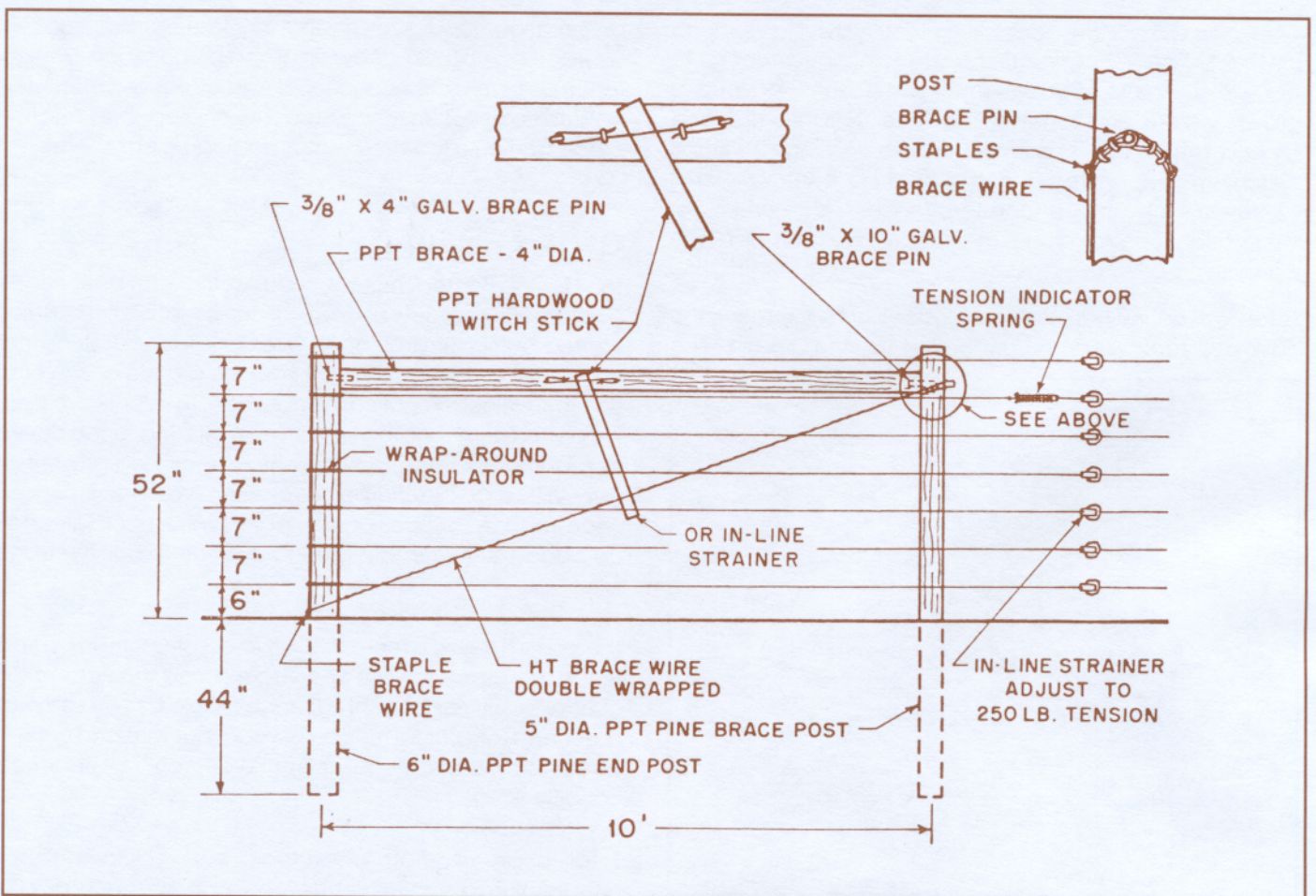

Figure 19. Horizontal Brace Assembly Details For 7-Wire Slanted Fence

run as much as five times the cost of vertical fence and three times that of slanted fence. However, the woven and smooth wire fences are more effective than any of the

electric single-stranded wire designs and require maintenance only for the posts and wire since no electrical components are used.

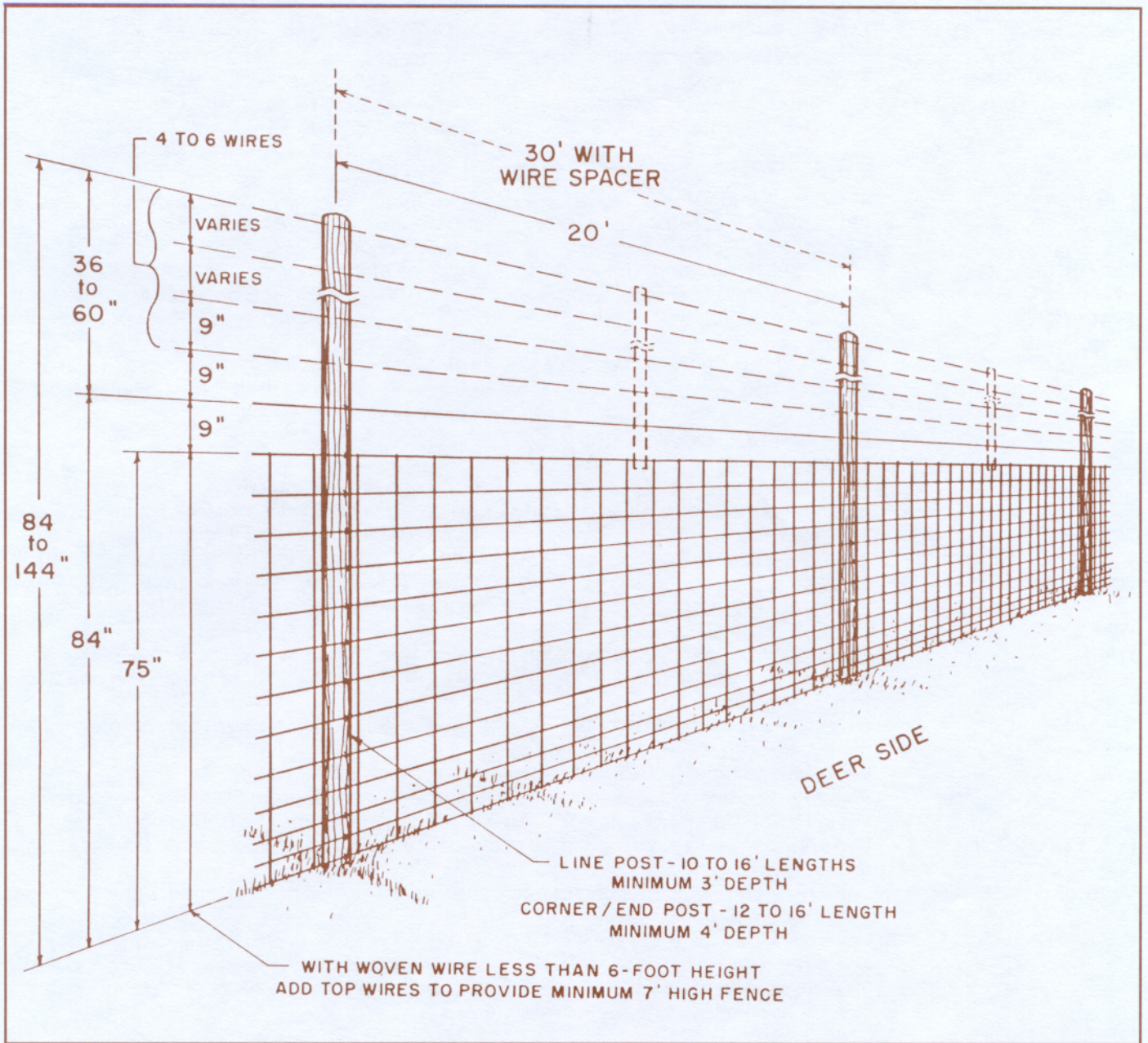

Figure 20. 7 to 12' High-Tensile Woven and Smooth Wire Non-Electric Deer Fence

Table 4. Specifications for 6-Wire Vertical Electric Anti-Deer Fence

	DIMENSIONS	INSTALLATION
POSTS		
End or corner (with bracing)	6" dia. x 9' - 10' long PPT pine or untreated locust	Set 4' - 5' deep, driven or hand-set.
Corner or direction change (no brace)	6" dia. x 9' - 10' long PPT pine or untreated locust	Set 4' - 5' deep, driven or hand-set, space 4' minimum. Lean 5" to outside bend: Single post 20° bend. Two post 40° bend. Three post 60° bend. Four post 80 - 90° bend (see Figure 2).
Line posts	4" - 5" dia. x 8' long PPT pine or untreated locust	Set 3' deep on all rises and depressions. 60' maximum spacing with wire spacers (battens) between posts.
Battens, droppers	60" long PPT hardwood, various sizes	Install at 20' - 30' spacing between line posts.
HD T-posts	60" - 69" long HD fiber glass T-post	Install at 20' - 30' spacing between line posts.
BRACING		
Brace posts	5" dia. x 9' - 10' long PPT pine or locust	Set 4' - 5' deep, driven or hand-set
Brace rail	4" dia. x 10' long PPT pine or 2" galvanized pipe.	Install horizontal brace rail between top 2 wires, diagonal brace rail top at same height on end or corner posts.
Brace pins	Galvanized 3/8" dia. steel rod, 10" and 4" long.	Pin brace rail to posts at both ends.
Brace wire	12 1/2 gauge HT Class 3 galvanized steel.	Horizontal brace - double wrap, tighten with twitch stick or in-line strainer (see Figure 12).
Brace rod	1/2" dia. x 10' 6" long galvanized steel	Diagonal brace - thread through bottom of end post and brace on top of floating foot (see Fig. 3).
Batten anchor	1 1/2" x 1 1/2" x 24" long PPT hardwood or earth anchor	Drive 2 stakes in "X" pattern in ground. Attach with stainless steel wire to batten (see Figure 9).
WIRE		
TYPE:	12 1/2 or 14 gauge HT Class 3 galvanized fence wire, minimum 1000 lbs. breaking strength.	
TENSION:	200 - 250 pounds. Tension with in-line strainers. Install a tension indicator spring on one wire to gauge tension.	
SPACING:	6 wires from ground up at 8", 10", 10", 10", 10", 10" (58"). Additional wires may be used with tighter spacing.	
INSULATORS:	Wrap-around tube, line wire tube, corner and end double-U, nail-on.	
FASTENING:	Preformed corner and end insulators, crimping sleeves or appropriate knots. Wire clips on self-insulating battens. 1 3/4" to 2" Class 3 or hot dipped galvanized staples.	
FENCE CHARGER:	Low impedance, high voltage, short impulse type. Select to charge specific length of fence.	
LIGHTNING ARRESTOR:	Install near charger, at the end of fence line, and at highest point in fence. Lightning choke is also recommended.	
GROUND RETURN:	Driven ground rods 6' long at least 6' apart, buried pipe or an existing metal object at each energizer, total length as specified by energizer manufacturer. Additional ground rod every 3000' for snow, wet, or tall grass conditions, or every 1500' for dry areas or prolonged ice conditions on alternating earth wire systems	
ELECTRIC FENCE SIGNS:	Post on fence at least at 150' - 200' intervals.	

- NOTES:**
- 1) Insulators must be used on pressure preservative treated softwood, salts-treated hardwood or locust.
 - 2) Selected pressure creosoted hardwood (ash, red and white oak, hickory or maple dried to 14 - 16% moisture) treated may be used without insulators.
 - 3) Additional lower wires at 5, 10, 15 - inch spacing above ground will effectively control raccoons, woodchucks and rabbits.

Table 5. Specifications for 7-Wire Slanted Electric Anti-Deer Fence

	DIMENSIONS	INSTALLATION
POSTS		
Corner or end posts	6" dia. x 8' long	Set 3' - 4' deep, driven or hand-set.
End or gate stub	6" dia. x 4' long	Set 3' deep, driven or hand-set.
Brace post	5" dia. x 8' long	Set 3' - 4' deep, driven or hand-set.
Line post	1 5/8" x 1 3/4" or 3" -4" dia. x 5' long	Set 18" deep, driven or hand-set.
Line post spacing	Every 60'	
RAILS		
End or gate	4" dia. or 4" x 4" x 10' long	Drilled and nailed to end or gate post and stub with 80d spike (hot dipped galvanized ring shank).
Line	1" x 3" x 7' long hardwood	Bolted to line post with a 3/8" x 3" galvanized bolt.
Batten	1/2" or 3/4" x 1 1/2" x 7' long hardwood	Wire clips fasten the spacer batten to the fence wires.
Batten spacing	1 batten halfway between line stations.	
BRACING		
Corner bracing	4" dia. x 10' long PPT post or 2" galvanized pipe.	
Brace wire	High tensile Class 3 galvanized wire	
WIRE		
TYPE:	High tensile Class 3 galvanized wire, 1000 lbs. breaking strength.	
TENSION:	200 - 250 pounds each strand. Tension with in-line strainer.	
SPACING:	From ground up rail - Electric: 10", 12", 12", 12", 12", 12", 12".	
FASTENING:	Wrap and tie or use crimping sleeves on corner hardwood rails. Use wire clips in line stations and spacer battens. Use insulators whenever wire touches non-insulated materials on the corners. Note: Wire clips used on line stations and spacers battens must allow the wire to slide freely.	
FENCE CHARGER:	Low impedance, high voltage, short pulse charger.	
LIGHTNING ARRESTORS:	Install near charger, at end of fence line and at highest point in fence. Lightning choke is also recommended.	
GROUND RETURN:	Four driven galvanized or copper-clad steel ground rods, 6' long, at least 6' apart or connect to existing steel culvert. Additional ground rod every 3000' for snow, wet, or tall grass conditions, or every 1500' for dry areas or prolonged ice conditions on alternating earth wire systems.	
ELECTRIC FENCE SIGNS:	Post on fence at least 150' - 200' intervals.	
<hr/>		
NOTES:	A variety of pressure preservative treated (PPT) wood and/or fiber glass products can be used. Insulators must be used with electric fences when self-insulating pressure-creosoted hardwood or fiberglass materials are not used. Wires added between the ground and first and second wires provide additional small animal control.	
<hr/>		

Table 6. Specifications for Woven and Smooth Wire Non-Electric Deer Fence

	DIMENSIONS	INSTALLATION
POSTS		
End or corner (with bracing)	6" dia. x 12' - 16' long PPT pine or untreated locust	Minimum 4' depth, driven or hand-set.
Corner or direction change (no bracing)	6" dia. x 12' - 16' long PPT pine or untreated locust	Minimum 4' depth, driven or hand-set, space 4' minimum. Lean 5° to outside of bend; Single post 20° bend; Two post 40° bend; Three post 60° bend; Four post 80-90° bend (see Fig. 2)
Line posts	5" dia. x 10' - 16' long PPT pine or untreated locust	Minimum 3' depth, driven or hand-set on all rises and depressions, 30' maximum spacing with wire spacers (battens) between line posts, 20' max. spacing if no battens.
Battens or droppers	40" to 60" PPT hardwood, various sizes	Install on smooth wires at midpoint between posts.
BRACING		
Brace posts	5" dia. x 11' - 17' long PPT pine or untreated locust	Minimum 4' depth, driven or hand-set.
Brace rail	4" dia. x 10' - 16' long PPT pine or 2" galv. steel pipe	Double brace assembly needed except for very short runs. Install horizontal brace rail at two-thirds the height for lower fences, one-half to two-thirds the height for higher fences. Diagonal brace rail at same height on end or corner post. Pin brace rail to posts at both ends.
Brace pins	Galvanized 3/8" dia. steel rod, 10" and 4" long	
Brace wire	HT galvanized	Horizontal brace - double wrap, staple ends to post, tighten with twitch stick (see Figure 12).
Brace rod	Galvanized 1/2" dia. steel rod	Diagonal brace - thread through bottom of end post and brace on top of floating foot (see Figure 3).
WIRE		
TYPE:	HT Class 3 galvanized woven fence wire, 49" and 75" height. 12 1/2 gauge HT Class 3 galvanized smooth wire.	
TENSION:	HT woven - stretch to flatten wire tension crimps half-way (about 5' per 20 rods of 330 feet). HT smooth - 250 lbs.	
STRAINERS:	HT woven - wire type fence stretcher; HT smooth - in-line strainer.	
TENSION INDICATOR:	For smooth wires, in-line tension spring, specified tension per unit length change.	
SPACING:	Woven: variable; Smooth wires: 9" for first two wires above woven, varies for additional strands.	
FASTENING:	1 3/4" to 2" Class 3 or hot dipped galvanized staples. Appropriate wire knots or crimping sleeves for splicing and end connections.	

MAINTENANCE AND SAFETY FOR HIGH-TENSILE FENCE

MAINTENANCE

High-tensile fence must be constructed according to design specifications to be effective over long periods of time. Although a principal advantage of high-tensile fences is the relative freedom from maintenance, sturdy construction does not eliminate the need for frequent inspection and maintenance. High-tensile fences are composed of many interrelated components; the failure of one component adversely affects the entire fence. In addition to routine inspections, the fence should be checked following severe summer storms and deep winter snows. All corners, brace assemblies, wire tensions, anchors, gates, electrical connections, line posts, and wire spacers should be inspected.

Vegetative growth beneath and around the fence should be controlled. Any vegetation in contact with the fence can cause decreased voltage due to grounding, while unattended woody plant growth can eventually distort wire spacing and cause structural damage. Vegetative control can be attained with cutting equipment or appropriate herbicides. A clear strip on one side of the fence makes fence inspection easier.

Specified line wire tension and spacing must be maintained at all times. Tension adjustments for extreme seasonal temperature changes should be made in early summer and late fall. Adjustments are also necessary after fence repairs. Adjustment methods are described in the non-electric fence section of this bulletin.

Fence voltage should be checked weekly with a fence tester, and immediately after lightning storms and deep snows. Check voltage first at the charger and then at a distant location from the charger. This is especially important for battery operated chargers which require a recharging every 3 to 10 weeks. Heavy duty wet cell batteries are recommended. Most chargers have easily replaceable electronic modules which can be damaged in lightning storms if the charger is not protected with lightning arrestors.

If voltage is adequate at the charger, but not at a distant location from charger, it is necessary to check voltage at several locations along the entire fence line to locate the cause. Grounding and "hot" wire connections at the charger should be checked before scouting the entire fence line.

Electrical charge on the fence must be maintained at all times. Studies have shown that deer frequently inspect

fences and quickly learn that the fence is no longer hot. During fence construction, the grounding system and charger should be installed first, so the fence can be electrified during non-working hours.

Following heavy storms, fences near trees or woods should be inspected for limb or tree fall and related structural damage. Debris should be removed to prevent grounding and repairs made as needed. Voltage should be checked after all repairs.

During periods of snow accumulation, fence voltage should be checked periodically to detect snow-pack grounding. If voltage drops below recommended levels, appropriate wire strands should be disconnected from the electrical system to maintain adequate voltage in the remaining wires. It is important that disconnected wires be reconnected as soon as snow melt occurs.

SAFETY IN HIGH-TENSILE WIRE FENCING

Anyone building wire fences is subject to cuts and scratches from the wire. Such injuries, as well as other accidents, can be prevented by observing certain safety precautions:

- Wear tightly woven, tough clothing that will not catch on the ends of the wire.
- Wear heavy duty, gauntlet-type leather gloves which fit snugly.
- Wear long pants and high work shoes with heavy soles to protect the feet and legs.
- Use the correct tool for each job, keep it in good condition, and use it only according to manufacturer's directions.
- Wear safety goggles or eye shields when cutting or tensioning the wire, as well as when driving nails or staples.
- Never carry nails or staples in pants pockets—use a nail apron or tool bag.
- Use proper shields on power equipment.
- Wear a hard hat and ear plugs or ear muffs when operating a power post driver.
- Use driving caps on posts as recommended by the post driver manufacturer.
- Keep children and livestock away from all fencing operations.

- When handling, driving, drilling, nailing, or stapling chemically-treated wood posts or lumber, wear face shields and rubber gloves, and cover otherwise unprotected areas of your skin. Some people are allergic to wood-preserving chemicals.
- Never use unsafe short-cuts or eliminate such items as safety wires on twitch sticks.
- Pick up all cut ends of wire, dropped staples and nails, etc., so they cannot cause injury to humans, be eaten by grazing livestock, or damage mower blades.
- Suspend all fence construction or maintenance and keep away from all fences during electrical storms.
- Install proper ground wires to wire fences as soon as they are erected.
- Remember, any wire is an excellent conductor. Be careful when stringing the guide wire or line wires so that they do not come near any overhead power lines or underground cables where you are working.
- When testing an electric fence with a voltmeter, wear rubber gloves or rubber-soled shoes to minimize any electric shock. Wearing a non-metallic hard hat is also recommended, since shocks about the head can be uncomfortable for hours. Any electrical shock is intensified if your hands, feet or clothing are wet from rain or perspiration.
- Warn all children that a fence is electrified and teach several responsible people how to switch off or disconnect the current to the fence in case of emergency.
- Affix electric fence warning signs at intervals not exceeding 200 feet on any segment of a fence which carries electrified wires.
- In areas with dry grass, reduce the output of your energizer to minimize the risk of fire.
- If you must test a fence for current without a voltmeter or test light, place the palm of one hand on the soil and slide a blade of green grass gradually forward against a live wire. A trickle of current through the grass indicates the current is on.

SAFETY IN ELECTRIC FENCING

When constructing electrical fences, observe the safety precautions listed above in addition to the following:

- Have all 110 or 120-volt supply lines for plug-in energizers installed according to local electrical code by a competent electrician.
- Install proper ground connections on power poles or buildings to protect them from lightning.
- Do not attempt to install any portion of an electric fence or to make repairs or tension adjustments with the current switched on. Disconnect the feed wires to the segment of fence on which you are working so the current cannot be accidentally switched on.
- Never grasp a wire on an electric fence with the closed hand. Even if you think the current is off, test a "live" wire first with the backs of your fingers. In the event of a shock, your reflex will pull your fingers away from the wire.
- Keep all metallic farm implements and any livestock tethered with chains away from electric fences.
- Do not attempt to repair or modify any electric fence energizer yourself. Return it to your authorized dealer for service.

These safety recommendations are reprinted with permission from "How to Build Fences With USS Max Ten 200 High-Tensile Fence Wire." 1980. Kiwi Fence, Inc.

REFERENCES

Anti-deer fencing installations. 1984. Kiwi Fence Systems, Waynesburg, PA 15370.

Benefit cost analysis of a deer-proof fence for apple orchards. 1979. Caslick, J. W. and D. J. Decker. Conservation Circular 15:5. Dept. of Natural Resources, Cornell University, Ithaca, NY 14853.

Controlling deer damage to orchards in New York. 1977. Caslick, J. W. and D. J. Decker. Conservation Circular 15:5. Dept. of Natural Resources, Cornell University, Ithaca, NY 14853.

Control methods to reduce deer damage to Pennsylvania agriculture. 1982. Wingard, Robert G. and W. L. Palmer. Final report to Pennsylvania Dept. of Agr. Pennsylvania State University, University Park, PA 16802.

Deer. 1982. Pennsylvania Wildlife Nuisance and Damage Control. Number 12. Pennsylvania Game Commission, Pennsylvania State University, U.S. Fish & Wildlife.

Deer and Agriculture in West Virginia. 1985. Agricultural Extension Committee on Deer Damage and Control Fact Sheet Series. West Virginia University, Morgantown, WV 26506.

- P-810 High-Tensile Fencing for Deer Damage Control
- P-811 Deer Damage Control in Gardens—Fencing
- P-812 High-tensile Woven and Smooth Wire Non-Electric Deer Fence
- P-813 Maintenance and Safety for High-Tensile Fences
- P-814 6-Wire Vertical High-Tensile Anti-Deer Fence
- P-816 Slanted High-Tensile Anti-Deer Fence
- P-817 3-Wire 2-Dimensional High-Tensile Electric Anti-Deer Fence
- P-819 High-Tensile Fencing - Do's and Don'ts

Deer damage control in New York agriculture. 1983. McAninch, J. B., M. R. Ellingwood and R. S. Winchcombe. NY State Dept. of Agriculture and Markets.

Deer damage control in orchards and vineyards in New York. 1982. McAninch, J. B. and R. S. Winchcombe. The New York Botanical Garden Cary Arboretum, Millbrook, NY 12545.

Deer fences and other contrivances. Wenger, Rob. Deer and Deer Hunting, June 1984.

Electric deer fence details. 1985. Wall, John R. Kiwi Fence Systems, Waynesburg, PA 15370.

Electric fencing as a deterrent to deer depredation. 1984. Karlsen, K. E. Performance Report for Federal Aid Project No. W-109-R-7 for Federal Aid in Wildlife Restoration Act, Texas Parks and Wildlife Dept.

Electric deer fencing. 1982. Palmer, W. L. and R. G. Wingard. Mimeo report. Penn State University, University Park, PA 16802.

Fencing Strategies for beef and sheep producers. 1984. Bulletin 688. West Virginia University Agricultural and Forestry Experiment Station, Morgantown, WV 26506.

Finally—practical control of deer damage. 1982. Palmer, W. L. and R. G. Wingard. Pennsylvania Farmer 207:2.

High-Tensile Electric Fence for Fencing All Classes of Livestock and Controlling Deer, Coyotes, Dogs, Bear. 1979. Henry and Cornelia Swayze, Brookside Electric Fencing, Tunbridge, VT 05077.

High-Tensile Wire Fence Systems. Koppers Company, Inc. Pittsburgh, PA 15219.

High-tensile fencing and trellising the Kiwi way. 102-K104. Kiwi Fence Systems, Waynesburg, PA 15370.

How to Build Fences with USS Max-Ten 200 High-Tensile Fence Wire. 1980. Kiwi Fence Inc., RD 2, Box 51A, Waynesburg, PA 15370.

How to Design and Build High-Tensile Plain Wire Fences. 1979. Koppers Co.

Koppers System: High-Tensile Fence. 1980. FP-959. Koppers Co., Inc.

Max-Flex Fence Systems. 1984. West Virginia Fence Corp., Lindside, WV 24950.

Pennsylvania State continues experiments with electric deer fencing. 1982. Palmer, W. L. and R. G. Wingard. Fruit South, Jan. 1982.

Planning Fences. 1980. American Association for Vocational Instructional Materials. Engineering Center, Athens, GA 30602.

Posts, Wire, Tools and Hardware for High-Tensile Wire Fencing. 1979. Bulletin 100. Kiwi Fence Systems, Inc., Waynesburg, PA 15370.

Recent Advances in Repellents and Fencing to Deter Deer Damage. 1980. J. B. McAninch. Proceedings New England Horticultural Society. 86:31-39.

Smooth-wire tension fences—design and construction. 1983. Mummert, Mark C., W. L. Kjelgaard and Zheng Ping Wu. Pennsylvania State Univ., Col. of Agr., Coop. Ext. Ser., University Park, PA 16802.

Tightlock deer fence, electric deer fence and high-tensile field fence. 1985. West Virginia Fence Corp., Lindside, WV 24951.

NRAES-11



Recycled
Paper

ISBN 0-935817-03-4



9 780935 817034

COOPERATIVE EXTENSION